



SCORRIMENTI | SLIDINGS | GLEITELEMENTE



# SYSTARK

## 2.0

Nel 2016 da due aziende leader nel settore della costruzione, commercializzazione di elementi normalizzati per stampi e soluzioni innovative per la lamiera, nasce **Systark**, che fa di esperienza e innovazione i punti fermi della sua missione aziendale atta alla distribuzione capillare di normalizzati per stampi e soluzioni meccaniche per gli stampisti e stampatori lamiera.

Appoggiandosi alle aziende fondatrici, **Systark** può contare su brand riconosciuti a livello internazionale, lavorazioni meccaniche, automazioni, asservimenti per presse, elementi costruiti dal gruppo e di un magazzino importante pronto ad assecondare le esigenze del settore.

**Systark** promuove un back office e supporto tecnico altamente professionale composto da commerciali, progettisti e meccanici con esperienza pluri-decennale nel settore deformazione lamiera a disposizione dei clienti. Grazie agli investimenti tecnologici, alla costante ricerca e miglioramento di cicli innovativi logistici, **Systark** mira ad offrire ai suoi collaboratori soluzioni personalizzate, accompagnate da un servizio quanto mai veloce ed affidabile.

---

**Systark** was born in 2016 from two leading companies specialized in standard die component engineering and marketing and innovative solutions for metal sheets. Experience and innovation are its core issues aimed at a detailed distribution of standard dies and mechanical solutions for mould makers and sheet metal printers.

Supported by its founding companies, **Systark** can rely on internationally acknowledged brands, mechanical productions, automations, presses servo-systems, products manufactured by its founding companies and a well-stocked warehouse ready to comply with sector requests.

**Systark** boasts a back office and a highly professional technical support, composed by sales managers, designers and technicians with a long-term experience in the metal sheet deformation field. Thanks to technological investments, continuous research and improvements of its innovative logistical cycles, Systark aims at offering her partners personalized solutions associated with a fast and reliable service.

**systark**



# SCORRIMENTI SLIDING

Il programma **Scorrimenti** scelto da Systark copre tutta la gamma di prodotti a livello mondiale e tutte direttive delle case automobilistiche, Systark propone: **bronzo-grafite, acciaio\*** per alti scorrimenti e sinterizzati.

I materiali scelti per la costruzione degli elementi sono selezionati e certificati, le finiture sono eseguite da macchine automatiche di ultima generazione, seguite da un capillare e severo controllo qualità effettuato da **Systark** stessa, all'interno dei propri stabilimenti.

---

The **sliding** format selected by Systark covers the whole worldwide product range and all car manufactures directives. Systark proposes: **bronze-graphite, high sliding steel** and **sintered**.

Systark choses selected and certified materials for its products, finishings are realised by latest generation automatic machinery and a detailed and severe quality control is the carried out by **Systark** itself in its own premises.

\*Note materiale / Materials notes: **Acciaio** / **Steel** 16MnCr5 HRC58-60, **Bronzo-grafite** > 190 HB





# INDICE

## CONTENTS

<b>S1.0</b>	<b>PIASTRA GUIDA IN ACCIAIO</b> WEAR PLATE STEEL DECKLEISTE STAHL	05
<b>S1.1</b>	<b>PIASTRA GUIDA BRONZO AUTOLUBRIFICANTE</b> WEAR PLATE SELF-LUBRICATING GLEITPLATTE BRONZE MIT FESTCHMIERSTOFF	35
<b>S2</b>	<b>GUIDA ANGOLARE BRONZO AUTOLUBRIFICANTE</b> ANGULAR GUIDE SELF-LUBRICATING WINKELLEISTE BRONZE MIT FESTCHMIERSTOFF	107
<b>S3</b>	<b>GUIDA T BRONZO AUTOLUBRIFICANTE</b> T-GUIDE SELF-LUBRICATING T-LISTE BRONZE MIT FESTCHMIERSTOFF	131
<b>S4</b>	<b>BUSSOLA BRONZO AUTOLUBRIFICANTE</b> BUSH SELF-LUBRICATING FÜHRUNGSBUCHSE	135
<b>S8</b>	<b>RALL DI SCORRIMENTO AUTOLUBRIFICANTE</b> THRUST WASHER SELF-LUBRICATING ANLAUFSCHLEIBE BRONZE MIT FESTCHMIERSTOFF	167





# PIASTRA GUIDA ACCIAIO S1.0

WEAR PLATE STEEL  
DECKLEISTE STAHL

**MATERIAL** 16MnCr5 **HARDNESS** 58-62 HRC

## S1.0 PIASTRA GUIDA IN ACCIAIO

S1.0 WEAR PLATE STEEL

S1.0 DECKLEISTE STAHL

### S1.000.10

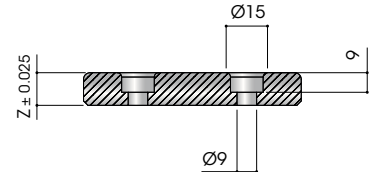
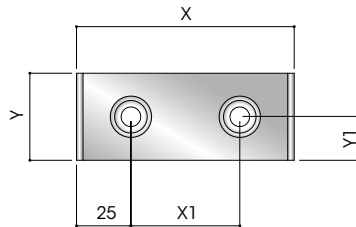

CODE	X	Y	Z	X1	Y1
S100010.008004015	80	40	15,1	30	20
S100010.010004015	100	40	15,1	50	20
S100010.012504015	125	40	15,1	75	20
S100010.016004015	160	40	15,1	110	20

CODE	X	Y	Z	X1	Y1
S100010.008006015	80	60	15,1	30	30
S100010.010006015	100	60	15,1	50	30
S100010.012506015	125	60	15,1	75	30
S100010.016006015	160	60	15,1	110	30

### S1.000.11

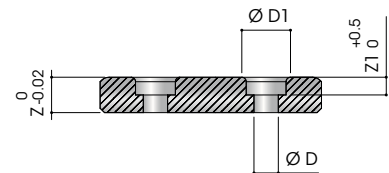
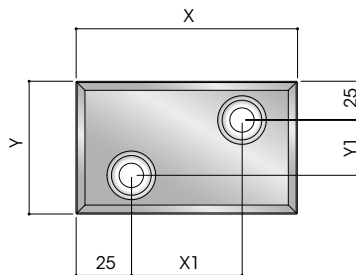

CODE	X	Y	Z	X1	Y1
S100011.010008025	100	80	25	50	30
S100011.012508025	125	80	25	75	30
S100011.016008025	160	80	25	110	30

CODE	X	Y	Z	X1	Y1
S100011.012510025	125	100	25	75	50
S100011.016010025	160	100	25	110	50

## S1.0 PIASTRA GUIDA IN ACCIAIO

S1.0 WEAR PLATE STEEL

S1.0 DECKLEISTE STAHL

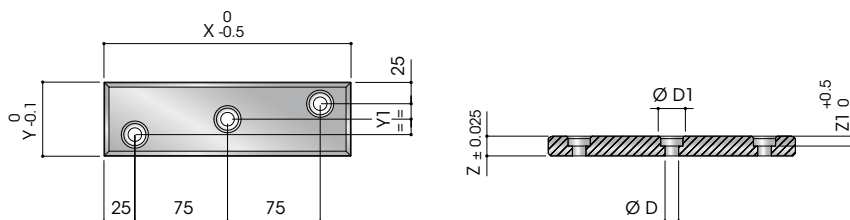

CODE	X	Y	Z	Y1
S100011.020008025	200	80	25	15
S100011.020010025	200	100	25	25

## S1.000.12

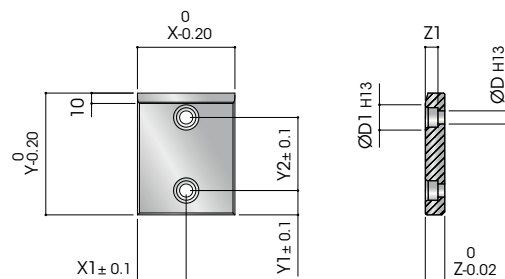

CODE	X	Y	Z	X1	Y1	D	D1	Z1
S100012.008006020	80	60	20	30	30	9	15	9
S100012.010006020	100	60	20	50	30	13,5	20	13
S100012.012506020	125	60	20	75	30	13,5	20	13
S100012.016006020	160	60	20	110	30	13,5	20	13
S100012.020006020	200	60	20	150	30	13,5	20	13
S100012.008009020	80	90	20	30	45	13,5	20	13
S100012.010009020	100	90	20	50	45	13,5	20	13
S100012.012509020	125	90	20	75	45	13,5	20	13
S100012.016009020	160	90	20	110	45	13,5	20	13
S100012.020009020	200	90	20	150	45	13,5	20	13
S100012.010011020	100	110	20	50	55	13,5	20	13
S100012.012511020	125	110	20	75	55	13,5	20	13
S100012.016011020	160	110	20	110	55	13,5	20	13
S100012.020011020	200	110	20	150	55	13,5	20	13

## S1.0 PIASTRA GUIDA IN ACCIAIO

S1.0 WEAR PLATE STEEL

S1.0 DECKLEISTE STAHL

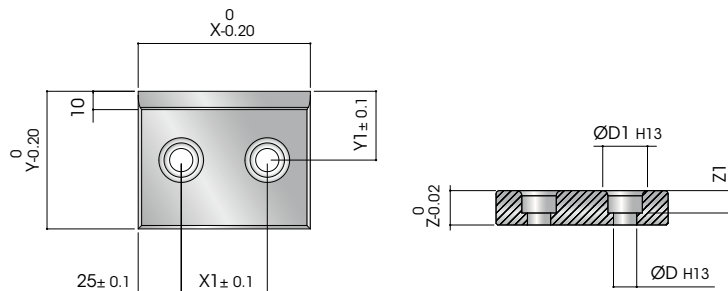

CODE	X	Y	Z	X1	Y1	D	D1	Z1
S100012.005009020	50	90	20	25	30	9	15	9
S100012.005011020	50	110	20	25	50	13,5	20	13
S100012.008011020	80	110	20	40	50	13,5	20	13
S100012.005013520	50	135	20	25	75	13,5	20	13
S100012.008013520	80	135	20	40	75	13,5	20	13
S100012.005017020	50	170	20	25	110	13,5	20	13
S100012.008017020	80	170	20	40	110	13,5	20	13

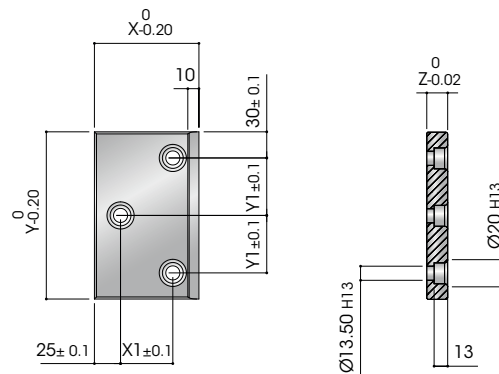

CODE	X	Y	Z	X1	Y1
S100012.010013520	100	135	20	50	37,5
S100012.012513520	125	135	20	75	37,5
S100012.016013520	160	135	20	110	37,5
S100012.020013520	200	135	20	150	37,5

CODE	X	Y	Z	X1	Y1
S100012.010017020	100	170	20	50	55
S100012.012517020	125	170	20	75	55
S100012.016017020	160	170	20	110	55
S100012.020017020	200	170	20	150	55

## S1.0 PIASTRA GUIDA IN ACCIAIO

S1.0 WEAR PLATE STEEL

S1.0 DECKLEISTE STAHL

### S1.000.13

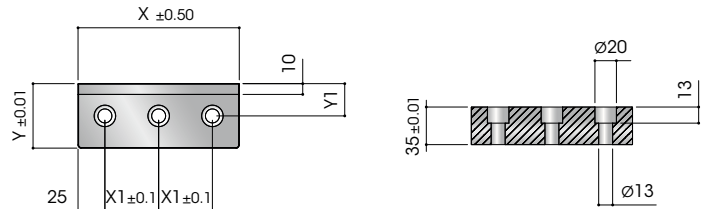

CODE	X	Y	Z	X1	Y1
S100013.015006035	150	60	35	50	30
S100013.020006035	200	60	35	75	30
S100013.025006035	250	60	35	100	30

CODE	X	Y	Z	X1	Y1
S100013.015008035	150	80	35	50	40
S100013.020008035	200	80	35	75	40
S100013.025008035	250	80	35	100	40

### S1.000.30

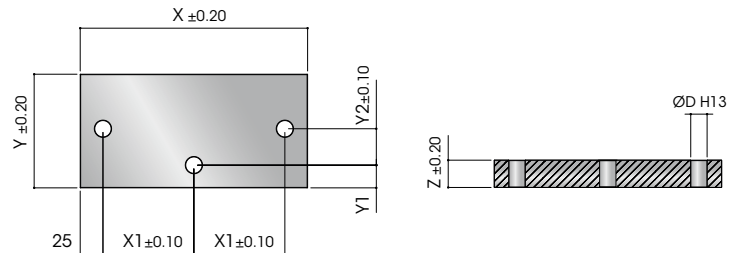

CODE	X	Y	Z	X1	Y1	Y2	D
S100030.016010020	160	100	20	55	20	20	14
S100030.020010020	200	100	20	75	20	20	14
S100030.025010020	250	100	20	100	20	20	14
S100030.016012530	160	125	30	55	25	40	18
S100030.025012530	250	125	30	100	25	40	18

## S1.0 PIASTRA GUIDA IN ACCIAIO

S1.0 WEAR PLATE STEEL

S1.0 DECKLEISTE STAHL

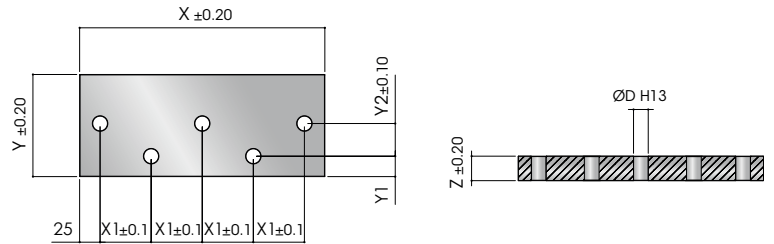

CODE	X	Y	Z	X1	Y1	Y2	D
S100030.030010020	300	100	20	62,5	20	20	14
S100030.030012530	300	125	30	62,5	25	40	18
S100030.035012530	350	125	30	75	25	40	18
S100030.040012530	400	125	30	87,5	25	40	18

## S1.000.31

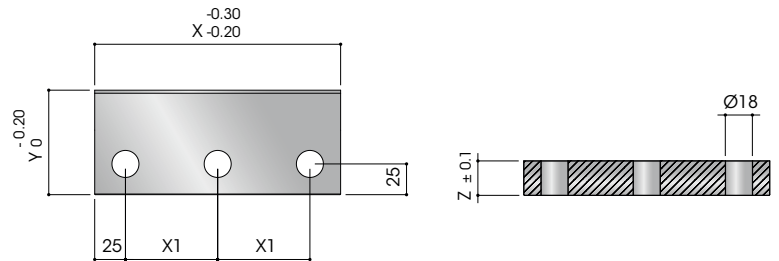

CODE	X	Y	Z	X1	CODE	X	Y	Z	X1
S100031.015006730	150	67	30	50	S100031.015008230	150	82	30	50
S100031.020006730	200	67	30	75	S100031.020008230	200	82	30	75



## S1.0 PIASTRA GUIDA IN ACCIAIO

S1.0 WEAR PLATE STEEL

S1.0 DECKLEISTE STAHL

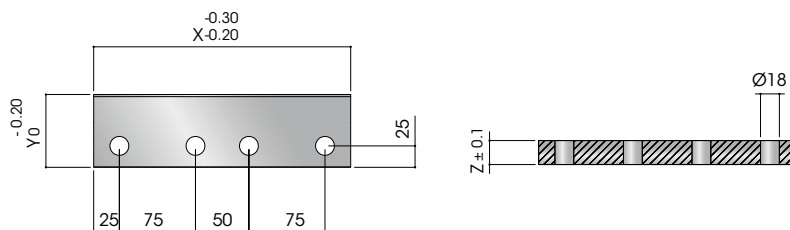

CODE	X	Y	Z
S100031.025006730	250	67	30
S100031.025008230	250	82	30

## S1.000.32

AFNOR/CROMO

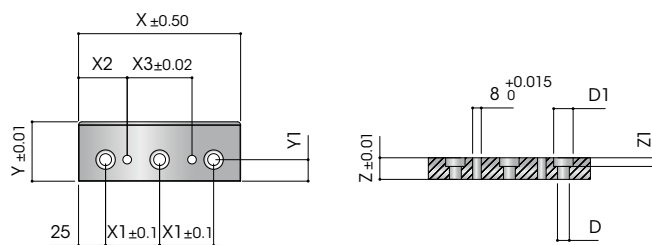

CODE	X	Y	Z	X1	X2	X3	Y1	D	D1	Z1
S100032.015005520	150	55	20	50	45	60	20	11	18	13
S100032.020005520	200	55	20	75	45	110	20	11	18	13
S100032.015008035	150	80	35	50	50	50	25	13	20	14
S100032.020008035	200	80	35	75	50	100	25	13	20	14
S100032.015009550	150	95	50	50	55	40	35	18	26	18
S100032.020009550	200	95	50	75	55	90	35	18	26	18

## S1.0 PIASTRA GUIDA IN ACCIAIO

S1.0 WEAR PLATE STEEL

S1.0 DECKLEISTE STAHL

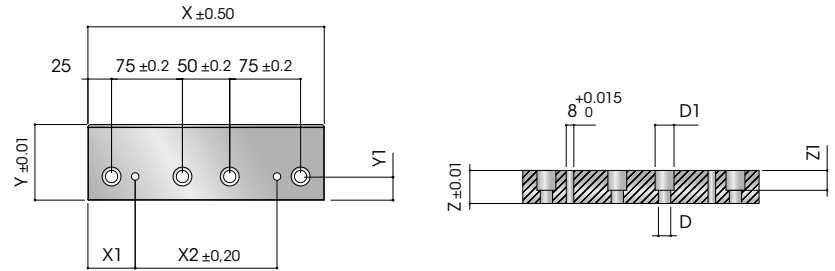

CODE	X	Y	Z	X1	X2	Y1	D	D1	Z1
S100032.025005520	250	55	20	45	160	20	11	18	12
S100032.025008035	250	80	35	50	150	25	13	20	14
S100032.025009550	250	95	50	55	140	35	18	26	18

## S1.002.11

AFNOR/CROMO

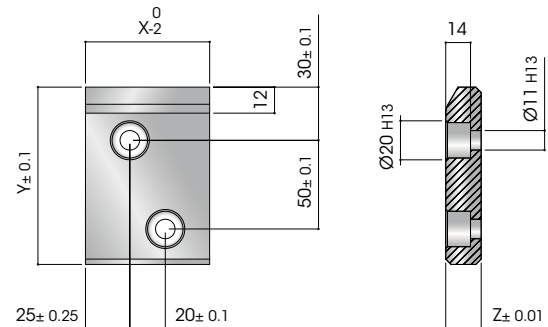

CODE	X	Y	Z
S100211.007010021	70	100	21

## S1.0 PIASTRA GUIDA IN ACCIAIO

S1.0 WEAR PLATE STEEL

S1.0 DECKLEISTE STAHL

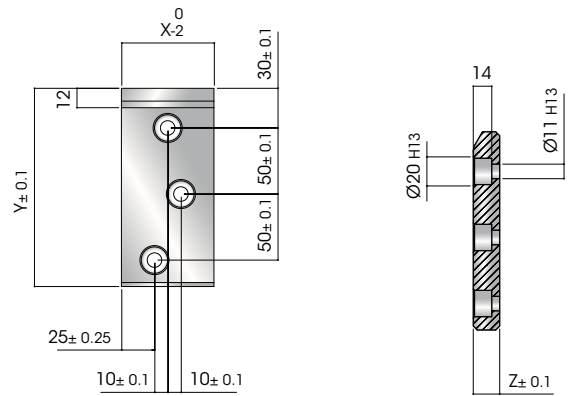

CODE	X	Y	Z
S100211.007015021	70	150	21

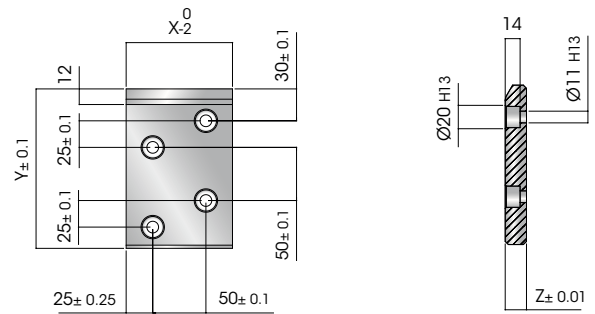

CODE	X	Y	Z
S100211.010015021	100	150	21

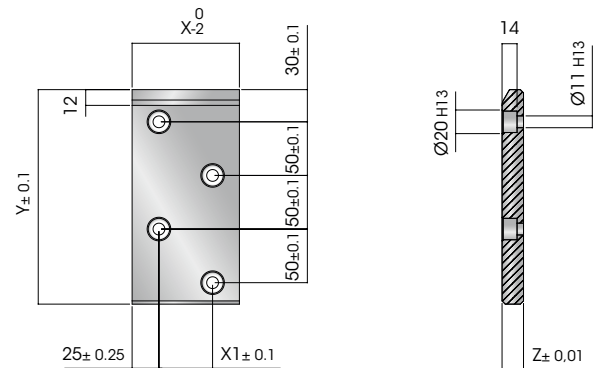

CODE	X	Y	Z	X1
S100211.007020021	70	200	21	20
S100211.010020021	100	200	21	50
S100211.015020021	150	200	21	100

## S1.0 PIASTRA GUIDA IN ACCIAIO

S1.0 WEAR PLATE STEEL

S1.0 DECKLEISTE STAHL

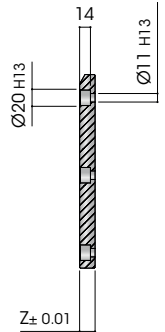
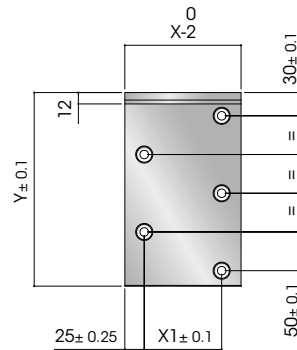

CODE	X	Y	Z	X1
S100211.010025021	100	250	21	50
S100211.015025021	150	250	21	100

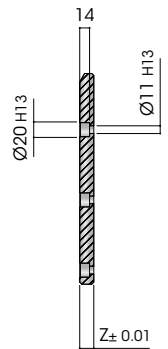
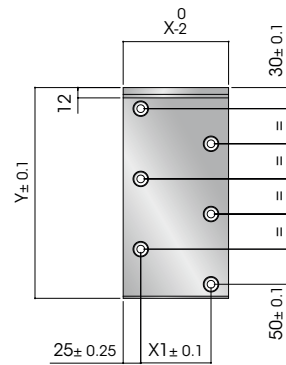

CODE	X	Y	Z	X1
S100211.010030021	100	300	21	50
S100211.015030021	150	300	21	100

## S1.0 PIASTRA GUIDA IN ACCIAIO

S1.0 WEAR PLATE STEEL

S1.0 DECKLEISTE STAHL

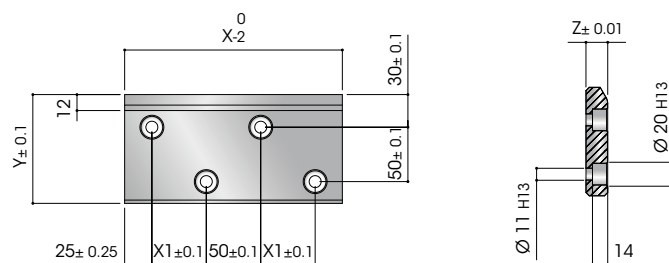

CODE	X	Y	Z	X1
S100211.010015021	150	100	21	25
S100211.020010021	200	100	21	50

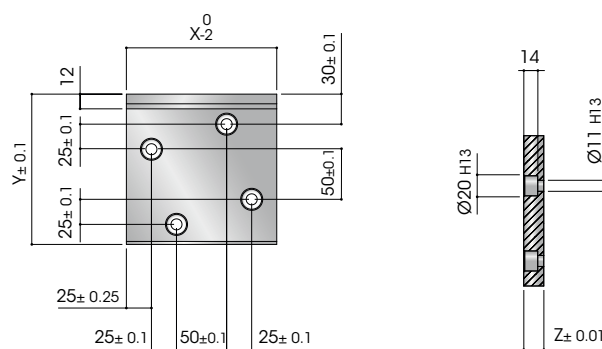

CODE	X	Y	Z
S100211.015015021	150	150	21

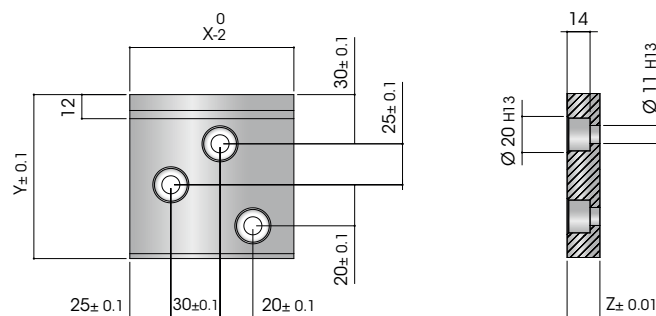

CODE	X	Y	Z
S100211.010010021	100	100	21

## S1.0 PIASTRA GUIDA IN ACCIAIO

S1.0 WEAR PLATE STEEL

S1.0 DECKLEISTE STAHL

### S1.003.10

VDI

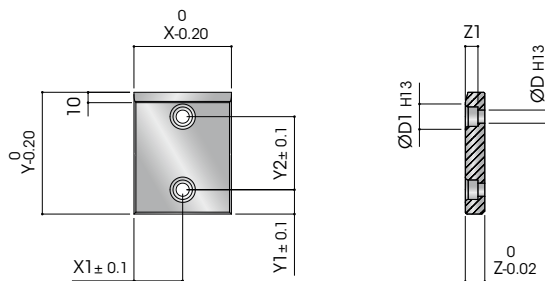

CODE	X	Y	Z	X1	Y1	Y2	Z1	D	D1
S100310.005008020	50	80	20	25	25	30	9	9	15
S100310.008008020	80	80	20	40	25	30	13	13,5	20
S100310.005010020	50	100	20	25	25	50	13	13,5	20
S100310.008010020	80	100	20	40	25	50	13	13,5	20
S100310.010010020	100	100	20	50	25	50	13	13,5	20
S100310.005012520	50	125	20	25	25	75	13	13,5	20
S100310.008012520	80	125	20	40	25	75	13	13,5	20
S100310.010012520	100	125	20	50	25	75	13	13,5	20
S100310.005016020	50	160	20	25	25	110	13	13,5	20
S100310.008016020	80	160	20	40	25	110	13	13,5	20
S100310.010016020	100	160	20	50	25	110	13	13,5	20
S100310.005020020	50	200	20	25	25	150	13	13,5	20
S100310.008020020	80	200	20	40	25	150	13	13,5	20
S100310.010020020	100	200	20	50	25	150	13	13,5	20
S100310.008025020	80	250	20	40	40	170	13	13,5	20
S100310.010025020	100	250	20	50	40	170	13	13,5	20
S100310.008031520	80	315	20	40	40	235	13	13,5	20
S100310.010031520	100	315	20	50	40	235	13	13,5	20

## S1.0 PIASTRA GUIDA IN ACCIAIO

S1.0 WEAR PLATE STEEL

S1.0 DECKLEISTE STAHL

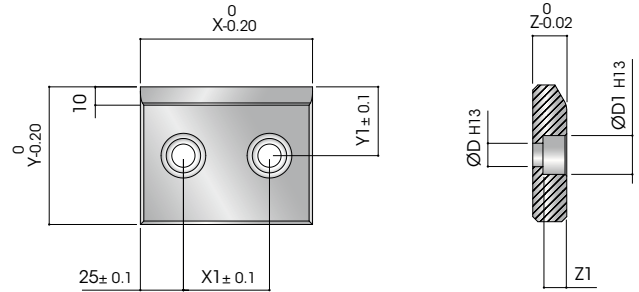

CODE	X	Y	Z	X1	Y1	Z1	D	D1
S100310.008005020	80	50	20	30	25	9	9	15
S100310.010005020	100	50	20	50	25	13	13,5	20
S100310.012505020	125	50	20	75	25	13	13,5	20
S100310.016005020	160	50	20	110	25	13	13,5	20
S100310.010008020	100	80	20	50	40	13	13,5	20
S100310.012508020	125	80	20	75	40	13	13,5	20
S100310.016008020	160	80	20	110	40	13	13,5	20

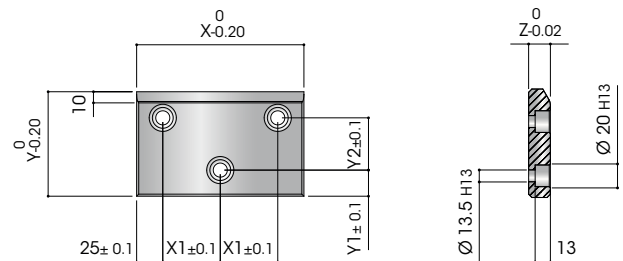

CODE	X	Y	Z	X1	Y1	Y2
S100310.012510020	125	100	20	37,5	25	50
S100310.016010020	160	100	20	55	25	50
S100310.012512520	125	125	20	37,5	25	75
S100310.016012520	160	125	20	55	25	75
S100310.012516020	125	160	20	37,5	25	110
S100310.016016020	160	160	20	55	25	110
S100310.012520020	125	200	20	37,5	25	150
S100310.016020020	160	200	20	55	25	150
S100310.012525020	125	250	20	37,5	40	170
S100310.012531520	125	315	20	37,5	40	235

## S1.0 PIASTRA GUIDA IN ACCIAIO

S1.0 WEAR PLATE STEEL

S1.0 DECKLEISTE STAHL

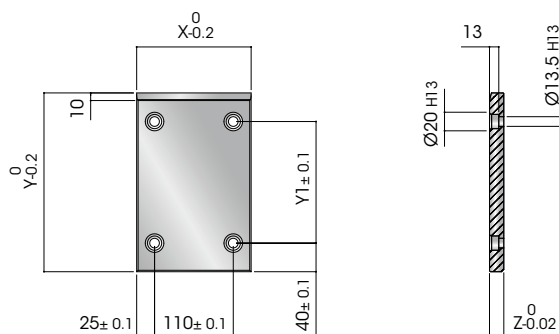

CODE	X	Y	Z	Y1
S100310.016025020	160	250	20	170
S100310.016031520	160	315	20	235

## S1.003.11

VDI

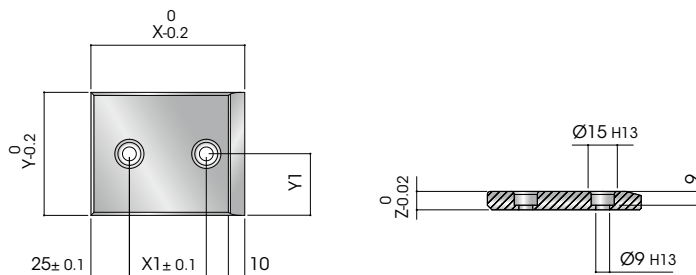

CODE	X	Y	Z	X1	Y1
S100311.008003012	80	30	12	30	15
S100311.010003012	100	30	12	50	15
S100311.012503012	125	30	12	75	15
S100311.016003012	160	30	12	110	15
S100311.020003012	200	30	12	150	15
S100311.008004012	80	40	12	30	20
S100311.010004012	100	40	12	50	20
S100311.012504012	125	40	12	75	20
S100311.016004012	160	40	12	110	20
S100311.020004012	200	40	12	150	20
S100311.022504012	225	40	12	175	20
S100311.008005012	80	50	12	30	25
S100311.010005012	100	50	12	50	25
S100311.012505012	125	50	12	75	25
S100311.016005012	160	50	12	110	25
S100311.018005012	180	50	12	130	25

CODE	X	Y	Z	X1	Y1
S100311.020005012	200	50	12	150	25
S100311.022505012	225	50	12	175	25
S100311.008006012	80	60	12	30	30
S100311.010006012	100	60	12	50	30
S100311.012506012	125	60	12	75	30
S100311.016006012	160	60	12	110	30
S100311.018006012	180	60	12	130	30
S100311.020006012	200	60	12	150	30
S100311.022506012	225	60	12	175	30
S100311.008008012	80	80	12	30	40
S100311.010008012	100	80	12	50	40
S100311.012508012	125	80	12	75	40
S100311.016008012	160	80	12	110	40
S100311.020008012	200	80	12	150	40
S100311.022508012	225	80	12	175	40



## S1.0 PIASTRA GUIDA IN ACCIAIO

S1.0 WEAR PLATE STEEL

S1.0 DECKLEISTE STAHL

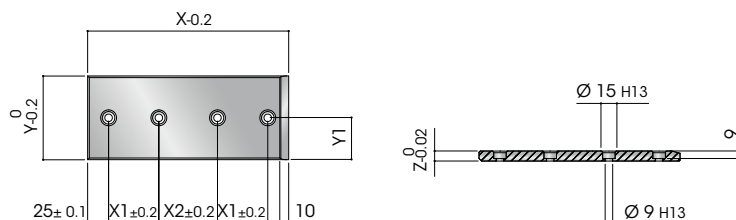

CODE	X	Y	Z	X1	X2	Y1
S100311.024004012	240	40	12	60	70	20
S100311.025004012	250	40	12	60	80	20
S100311.026004012	260	40	12	60	90	20
S100311.028004012	280	40	12	60	110	20
S100311.024005012	240	50	12	60	70	25
S100311.025005012	250	50	12	60	80	25
S100311.026005012	260	50	12	60	90	25
S100311.028005012	280	50	12	60	110	25
S100311.030005012	300	50	12	80	90	25
S100311.035005012	350	50	12	100	100	25
S100311.040005012	400	50	12	120	110	25
S100311.024006012	240	60	12	60	70	30
S100311.025006012	250	60	12	60	80	30
S100311.026006012	260	60	12	60	90	30
S100311.028006012	280	60	12	60	110	30
S100311.030006012	300	60	12	80	90	30
S100311.032006012	320	60	12	80	110	30
S100311.034006012	340	60	12	80	130	30
S100311.035006012	350	60	12	100	100	30
S100311.024008012	240	80	12	60	70	40
S100311.025008012	250	80	12	60	80	40
S100311.026008012	260	80	12	60	90	40
S100311.028008012	280	80	12	60	110	40
S100311.030008012	300	80	12	80	90	40
S100311.032008012	320	80	12	80	110	40
S100311.034008012	340	80	12	80	130	40
S100311.035008012	350	80	12	100	100	40
S100311.025010012	250	100	12	60	80	50
S100311.028010012	280	100	12	60	110	50
S100311.030010012	300	100	12	80	90	50
S100311.032010012	320	100	12	80	110	50
S100311.034010012	340	100	12	80	130	50
S100311.035010012	350	100	12	100	100	50

## S1.0 PIASTRA GUIDA IN ACCIAIO

S1.0 WEAR PLATE STEEL

S1.0 DECKLEISTE STAHL

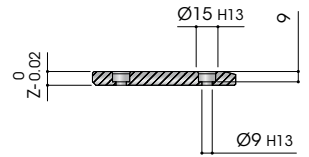
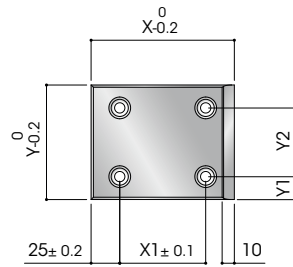

CODE	X	Y	Z	X1	Y1	Y2
S100311.012510012	125	100	12	75	25	50
S100311.016010012	160	100	12	110	25	50
S100311.020010012	200	100	12	150	20	50
S100311.022510012	225	100	12	175	25	50
S100311.B25010012	250	100	12	200	25	50
S100311.B30010012	300	100	12	250	20	60
S100311.014512512	145	125	12	95	20	85
S100311.016012512	160	125	12	110	20	85
S100311.014515012	145	150	12	95	20	110
S100311.016015012	160	150	12	110	20	110

## S1.003.12

VDI

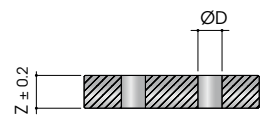
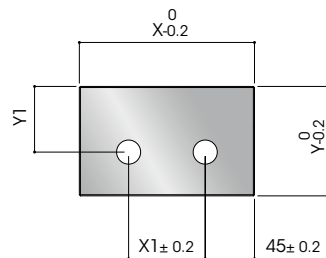

CODE	X	Y	Z	X1	Y1	D
S100312.016003510	160	35	10	70	20	11
S100312.020003510	200	35	10	110	20	11
S100312.016004515	160	45	15	70	30	13,5
S100312.020004515	200	45	15	110	30	13,5
S100312.016005515	160	55	15	70	35	13,5

## S1.0 PIASTRA GUIDA IN ACCIAIO

S1.0 WEAR PLATE STEEL

S1.0 DECKLEISTE STAHL

CODE	X	Y	Z	X1	Y1	D
S100312.020005515	200	55	15	110	35	17,5
S100312.016007525	160	75	25	70	40	17,5
S100312.020007525	200	75	25	110	40	17,5
S100312.016010025	160	100	25	70	60	17,5
S100312.020010025	200	100	25	110	60	17,5
S100312.016012525	160	125	25	70	75	17,5
S100312.020012525	200	125	25	110	75	17,5
S100312.016008530	160	85	30	70	60	22
S100312.020008530	200	85	30	110	60	22
S100312.016010030	160	100	30	70	60	22
S100312.020010030	200	100	30	110	60	22
S100312.016012530	160	125	30	70	75	22
S100312.020012530	200	125	30	110	75	22

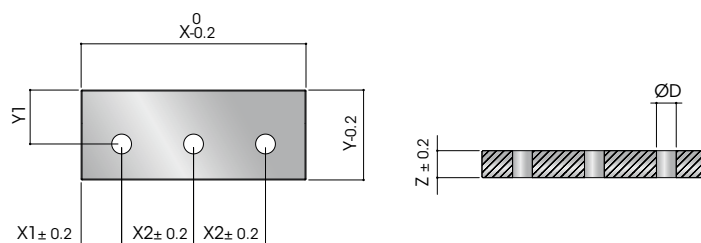

CODE	X	Y	Z	X1	X2	Y1	D
S100312.025003510	250	35	10	45	80	20	11
S100312.025004515	250	45	15	45	80	30	13,5
S100312.025005515	250	55	15	45	80	35	17,5
S100312.025007525	250	75	25	45	80	40	17,5
S100312.B20008530	200	85	30	45	55	60	22
S100312.024008528	240	85	28	25	95	60	22
S100312.025008530	250	85	30	45	80	60	22
S100312.030008530	300	85	30	45	105	60	22
S100312.035008530	350	85	30	45	130	60	22
S100312.025010025	250	100	25	45	80	60	17,5
S100312.025010030	250	100	30	45	80	60	22
S100312.025012525	250	125	25	45	80	75	17,5
S100312.025012530	250	125	30	45	80	75	22
S100312.030012530	300	125	30	45	105	75	22
S100312.035012530	350	125	30	45	130	75	22

## S1.0 PIASTRA GUIDA IN ACCIAIO

S1.0 WEAR PLATE STEEL

S1.0 DECKLEISTE STAHL

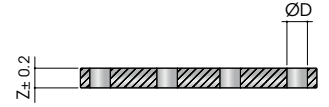
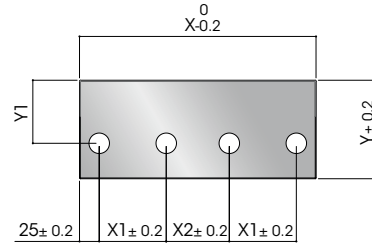

CODE	X	Y	Z	X1	X2	Y1	D
S100312.030012525	300	125	25	85	80	80	26
S100312.035012525	350	125	25	100	100	80	26
S100312.040012525	400	125	25	115	120	80	26
S100312.030008528	300	85	28	85	80	60	22
S100312.035008528	350	85	28	100	100	60	22
S100312.040008528	400	85	28	115	120	60	22

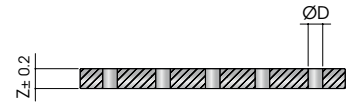
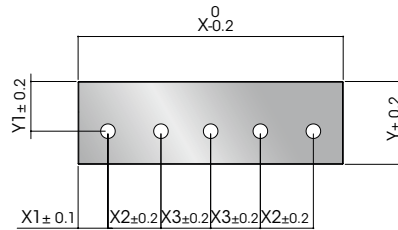

CODE	X	Y	Z	X1	X2	X3	Y1	D
S100312.040010025	400	100	25	45	80	75	60	17,5
S100312.040012525	400	125	25	45	80	75	75	17,5
S100312.045012525	450	125	25	25	100	100	80	26
S100312.050012525	500	125	25	25	110	115	80	26
S100312.045008528	450	85	28	25	100	100	60	22
S100312.040008530	400	85	30	45	80	75	60	22
S100312.040010030	400	100	30	45	80	75	60	22
S100312.040012530	400	125	30	45	80	75	75	22
S100312.045012530	450	125	30	50	80	95	75	22
S100312.050012530	500	125	30	50	80	120	75	22

## S1.0 PIASTRA GUIDA IN ACCIAIO

S1.0 WEAR PLATE STEEL

S1.0 DECKLEISTE STAHL

### S1.004.10

NAAMS W03

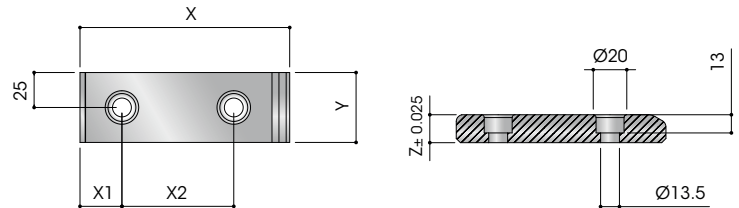

CODE	X	Y	Z	X1	X2
S100410.010005020	100	50	20	30	30
S100410.015005020	150	50	20	30	80
S100410.020005020	200	50	20	40	120

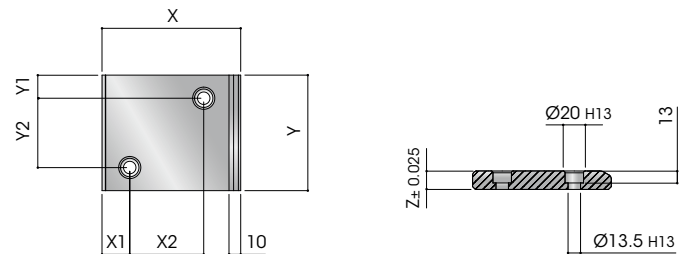

CODE	X	Y	Z	X1	X2	Y1	Y2
S100410.010008020	100	80	20	30	30	20	40
S100410.015008020	150	80	20	30	80	20	40
S100410.020008020	200	80	20	40	120	20	40
S100410.025008020	250	80	20	40	170	20	40
S100410.010010020	100	100	20	30	30	22	56
S100410.015010020	150	100	20	30	80	22	56
S100410.010012520	100	125	20	30	30	25	75
S100410.015012520	150	125	20	30	80	25	75
S100410.010016020	100	160	20	30	30	30	100
S100410.015016020	150	160	20	30	80	30	100

## S1.0 PIASTRA GUIDA IN ACCIAIO

S1.0 WEAR PLATE STEEL

S1.0 DECKLEISTE STAHL

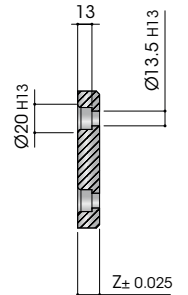
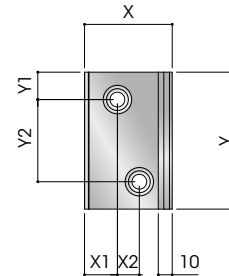

CODE	X	Y	Z	X1	X2	Y1	Y2
S100410.005010020	50	100	20	14	13	22	56
S100410.008010020	80	100	20	30	20	22	56
S100410.008012520	80	125	20	30	20	25	75

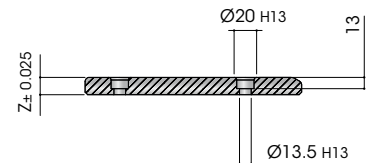
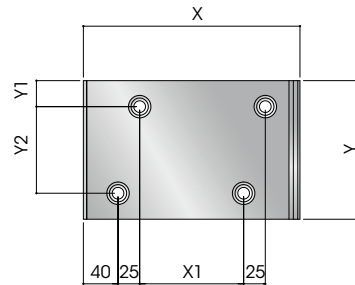

CODE	X	Y	Z	X1	Y1	Y2
S100410.031512520	315	125	20	185	25	75
S100410.025016020	250	160	20	120	30	100
S100410.031516020	315	160	20	185	30	100

# S1.0 PIASTRA GUIDA IN ACCIAIO

S1.0 WEAR PLATE STEEL

S1.0 DECKLEISTE STAHL

## S1.005.11

AFNOR

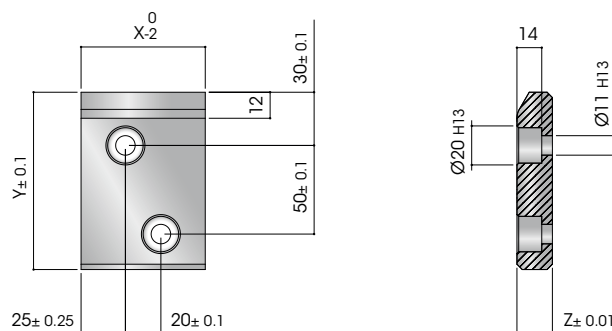

CODE	X	Y	Z
S100511.007010020	70	100	20

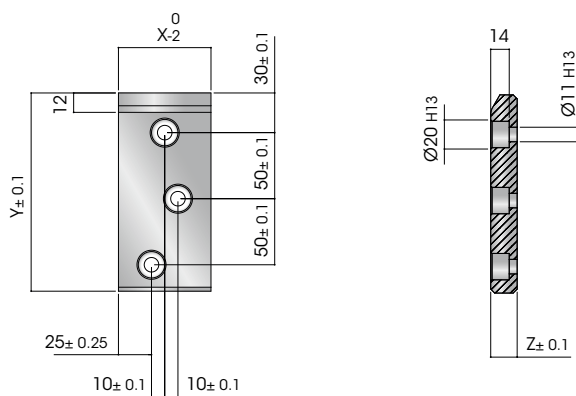

CODE	X	Y	Z
S100511.007015020	70	150	20

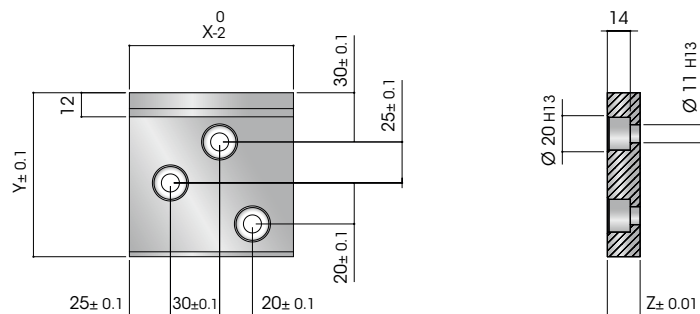

CODE	X	Y	Z
S100511.010010020	100	100	20

## S1.0 PIASTRA GUIDA IN ACCIAIO

S1.0 WEAR PLATE STEEL

S1.0 DECKLEISTE STAHL

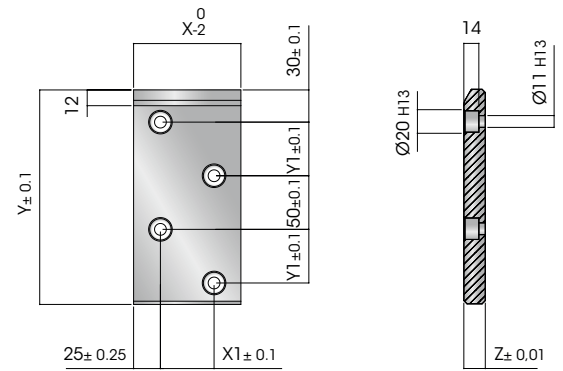

CODE	X	Y	Z	X1	Y1
S100511.007020020	70	200	20	20	50
S100511.010020020	100	200	20	50	50
S100511.015020020	150	200	20	100	50

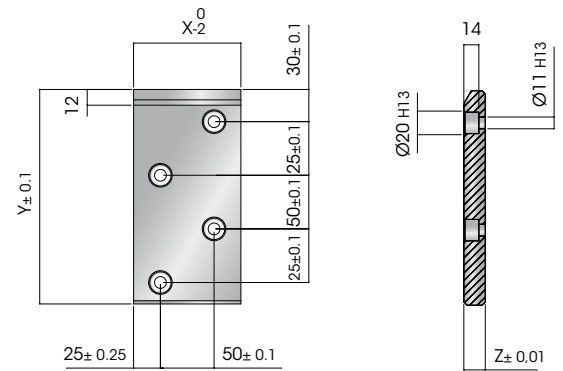

CODE	X	Y	Z
S100511.01001520	100	150	20

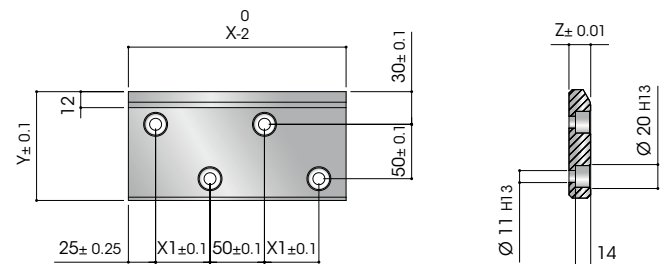

CODE	X	Y	Z	X1
S100511.015010020	150	100	20	25
S100511.020010020	200	100	20	50



## S1.0 PIASTRA GUIDA IN ACCIAIO

S1.0 WEAR PLATE STEEL

S1.0 DECKLEISTE STAHL

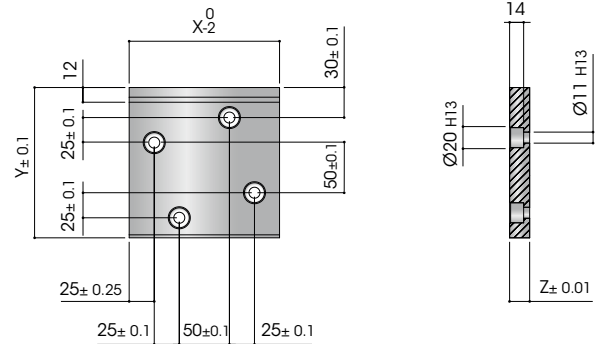

CODE	X	Y	Z
S100511.015015020	150	150	20

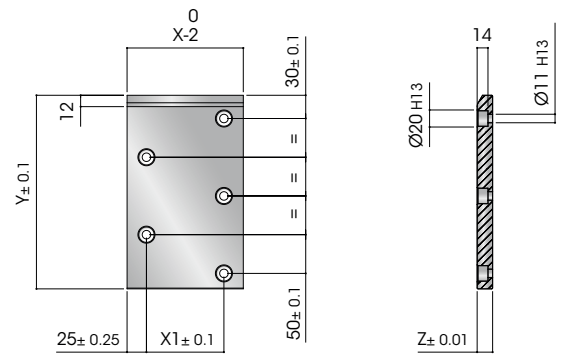

CODE	X	Y	Z	X1
S100511.010025020	100	250	20	50
S100511.015025020	150	250	20	100

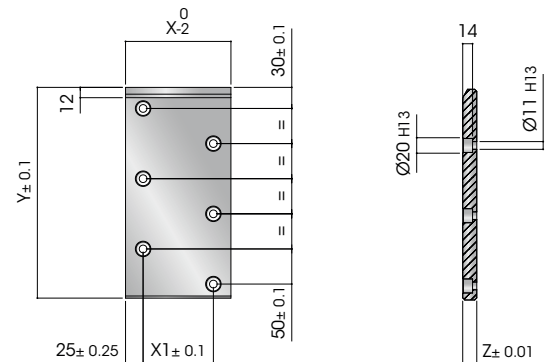

CODE	X	Y	Z	X1
S100511.010030020	100	300	20	50
S100511.015030020	150	300	20	100

**S1.0 PIASTRA GUIDA IN ACCIAIO**

S1.0 WEAR PLATE STEEL

S1.0 DECKLEISTE STAHL

**S1.005.12**

CNOMO

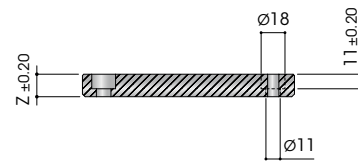
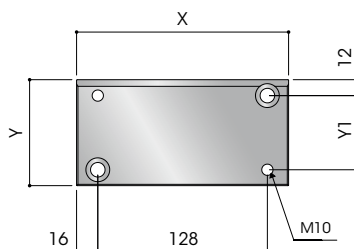

CODE	X	Y	Z	Y1
S100512.016005017	160	50	17	26
S100512.016008017	160	80	17	56

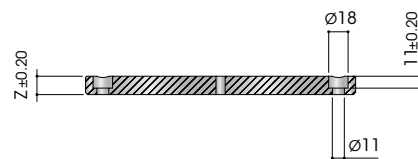
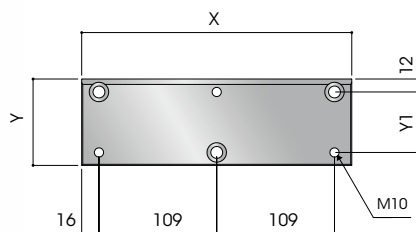

CODE	X	Y	Z	Y1
S100512.025005017	250	50	17	26
S100512.025008017	250	80	17	56

## S1.0 PIASTRA GUIDA IN ACCIAIO

S1.0 WEAR PLATE STEEL

S1.0 DECKLEISTE STAHL

### S1.005.30

CNOMO

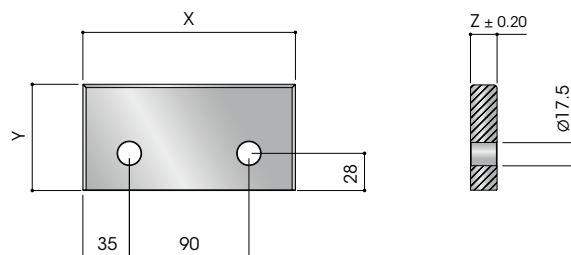

CODE	X	Y	Z
S100530.016008020	160	80	20

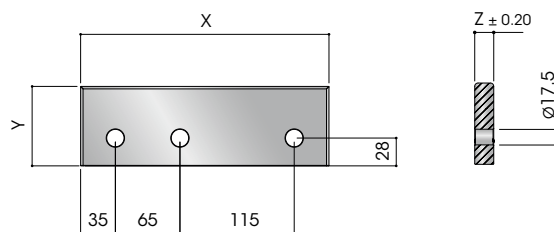

CODE	X	Y	Z
S100530.025008020	250	80	20

## S1.0 PIASTRA GUIDA IN ACCIAIO

S1.0 WEAR PLATE STEEL

S1.0 DECKLEISTE STAHL

### S1.006.10

FCA

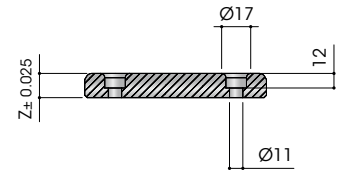
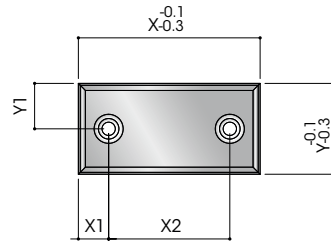

CODE	X	Y	Z	X1	X2	Y1
S100610.007503820	75	38	20	15	45	19
S100610.010003820	100	38	20	25	50	19
S100610.015003820	150	38	20	25	100	19
S100610.020003820	200	38	20	25	150	19
S100610.007504820	75	48	20	15	45	24
S100610.010004820	100	48	20	25	50	24
S100610.012504820	125	48	20	25	75	24
S100610.015004820	150	48	20	25	100	24
S100610.020004820	200	48	20	25	150	24
S100610.025004820	250	48	20	25	200	24
S100610.007507520	75	75	20	15	45	37,5
S100610.B07507520	75	75	20	25	25	37,5
S100610.B10007520	100	75	20	25	50	37,5
S100610.012507520	125	75	20	25	75	37,5
S100610.015007520	150	75	20	25	100	37,5
S100610.020007520	200	75	20	25	150	37,5
S100610.025007520	250	75	20	25	200	37,5

## S1.0 PIASTRA GUIDA IN ACCIAIO

S1.0 WEAR PLATE STEEL

S1.0 DECKLEISTE STAHL

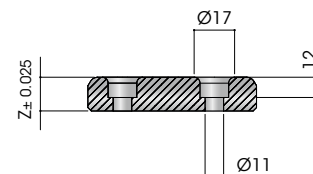
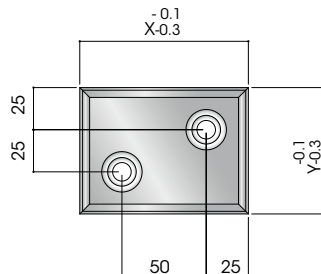

CODE	X	Y	Z
S100610.010007520	100	75	20

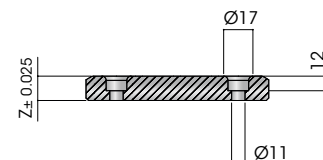
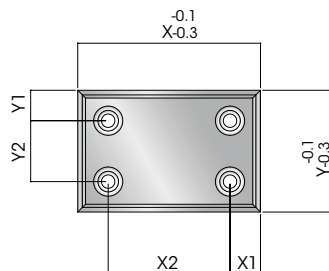

CODE	X	Y	Z	X1	X2	Y1	Y2
S100610.010010020	100	100	20	25	50	25	50
S100610.012510020	125	100	20	25	75	25	50
S100610.015010020	150	100	20	25	100	25	50
S100610.020010020	200	100	20	25	150	25	50
S100610.025010020	250	100	20	25	200	25	50
S100610.030010020	300	100	20	25	250	25	50
S100610.012512520	125	125	20	25	75	37,5	50
S100610.015012520	150	125	20	25	100	37,5	50
S100610.020012520	200	125	20	25	150	37,5	50
S100610.025012520	250	125	20	25	200	37,5	50
S100610.030012520	300	125	20	50	200	37,5	50
S100610.035012520	350	125	20	75	200	37,5	50
S100610.015015020	150	150	20	25	100	25	100
S100610.020015020	200	150	20	25	150	25	100
S100610.025015020	250	150	20	25	200	25	100

**S1.0 PIASTRA GUIDA IN ACCIAIO**

S1.0 WEAR PLATE STEEL

S1.0 DECKLEISTE STAHL

**S1.006.11**

FCA

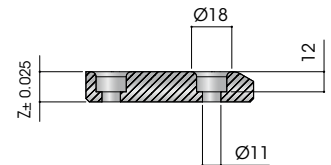
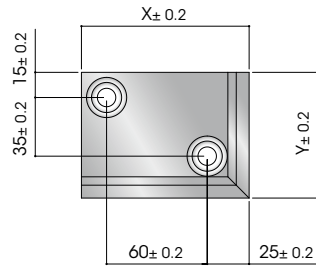

CODE	X	Y	Z
S100611.010007518	100	75	18

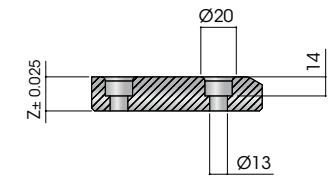
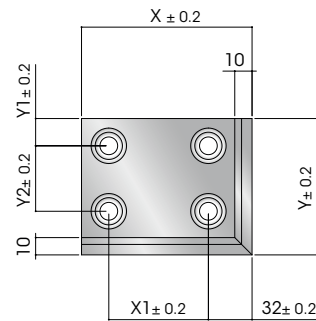

CODE	X	Y	Z	Y1	Y2	X1
S100611.012510025	125	100	25	20	48	73
S100611.015012525	150	125	25	25	68	93

## S1.0 PIASTRA GUIDA IN ACCIAIO

S1.0 WEAR PLATE STEEL

S1.0 DECKLEISTE STAHL

### S1.006.12

FCA

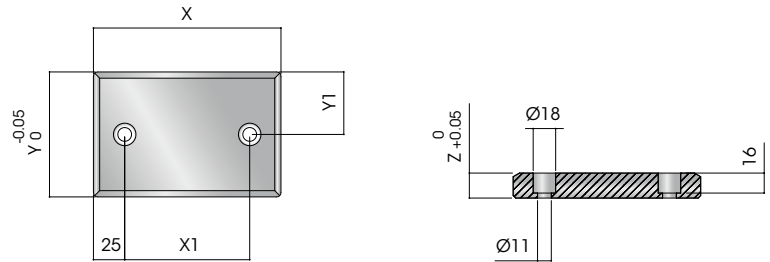

CODE	X	Y	Z	X1	Y1
S100612.010004820	100	48	20	50	24
S100612.015004820	150	48	20	100	24
S100612.010007520	100	75	20	50	37,5
S100612.015007520	150	75	20	100	37,5

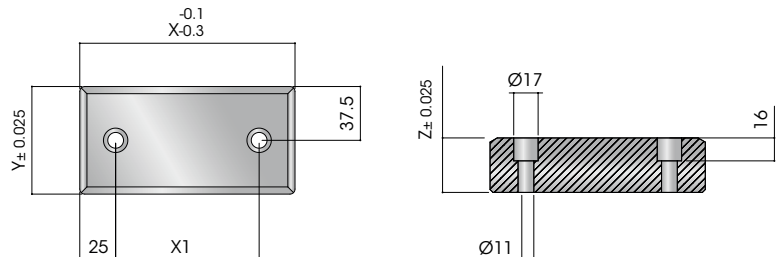

CODE	X	Y	Z	X1
S100612.010007538	100	75	38	50
S100612.015007538	150	75	38	100





PIASTRA  
GUIDA  
BRONZO  
AUTOLUBRIFICANTE  
**S1.1**

WEAR PLATE SELF-LUBRICATING  
GLEITPLATTE BRONZE MIT FESTCHMIERSTOFF

**MATERIAL** BRONZE with solid lubricant **HARDENESS** >190 HB

## S1.1 PIASTRA GUIDA BRONZO AUTOLUBRIFICANTE

S1.1 WEAR PLATE SELF-LUBRICATING

S1.1 GLEITPLATTE BRONZE MIT FESTSCHMIERSTOFF

### S1.110.00

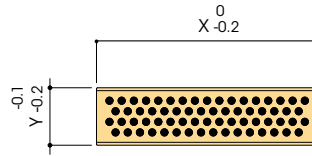

CODE	X	Y	Z
S111000.005002505	50	25	5
S111000.007102505	71	25	5
S111000.009002505	90	25	5
S111000.005004005	50	40	5
S111000.007104005	71	40	5
S111000.009004005	90	40	5
S111000.005002506	50	25	6
S111000.006302506	63	25	6
S111000.008002506	80	25	6
S111000.010002506	100	25	6
S111000.012502506	125	25	6
S111000.050002506	500	25	6
S111000.008004006	80	40	6
S111000.010004006	100	40	6
S111000.012504006	125	40	6

CODE	X	Y	Z
S111000.016004006	160	40	6
S111000.020004006	200	40	6
S111000.050004006	500	40	6
S111000.008006306	80	63	6
S111000.010006306	100	63	6
S111000.012506306	125	63	6
S111000.016006306	160	63	6
S111000.012506308	125	63	8
S111000.016006308	160	63	8
S111000.020006308	200	63	8
S111000.025006308	250	63	8
S111000.031506308	315	63	8
S111000.050006308	500	63	8
S111000.050008010	500	80	10

## S1.1 PIASTRA GUIDA BRONZO AUTOLUBRIFICANTE

S1.1 WEAR PLATE SELF-LUBRICATING

S1.1 GLEITPLATTE BRONZE MIT FESTSCHMIERSTOFF

### S1.110.01

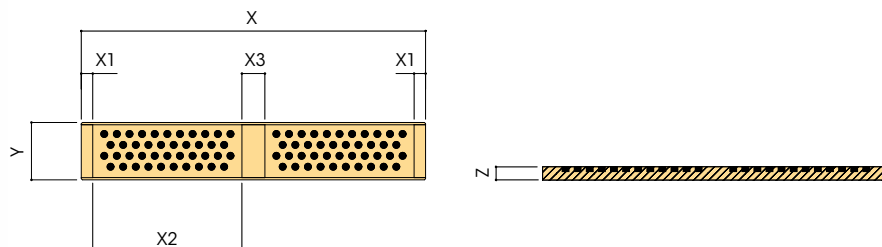

CODE	X	Y	Z	X1	X2	X3
S111001.030005010	300	50	10	11	128	22
S111001.060005010	600	50	10	11	128	22
S111001.105005010	1050	50	10	11	128	22
S111001.120005010	1200	50	10	11	128	22
S111001.150005010	1500	50	10	11	128	22
S111001.030008010	300	80	10	11	128	22
S111001.060008010	600	80	10	11	128	22
S111001.105008010	1050	80	10	11	128	22
S111001.120008010	1200	80	10	11	128	22
S111001.150008010	1500	80	10	11	128	22
S111001.030010010	300	100	10	11	128	22
S111001.060010010	600	100	10	11	128	22
S111001.105010010	1050	100	10	11	128	22
S111001.120010010	1200	100	10	11	128	22
S111001.150010010	1500	100	10	11	128	22
S111001.030015010	300	150	10	11	128	22
S111001.060015010	600	150	10	11	128	22
S111001.105015010	1050	150	10	11	128	22
S111001.120015010	1200	150	10	11	128	22
S111001.150015010	1500	150	10	11	128	22
S111001.030005020	300	50	20	14	122	28
S111001.060005020	600	50	20	14	122	28
S111001.105005020	1050	50	20	14	122	28
S111001.120005020	1200	50	20	14	122	28
S111001.150005020	1500	50	20	14	122	28
S111001.030008020	300	80	20	14	122	28
S111001.060008020	600	80	20	14	122	28
S111001.105008020	1050	80	20	14	122	28
S111001.120008020	1200	80	20	14	122	28
S111001.150008020	1500	80	20	14	122	28
S111001.030010020	300	100	20	14	122	28
S111001.060010020	600	100	20	14	122	28
S111001.105010020	1050	100	20	14	122	28

## S1.1 PIASTRA GUIDA BRONZO AUTOLUBRIFICANTE

S1.1 WEAR PLATE SELF-LUBRICATING

S1.1 GLEITPLATTE BRONZE MIT FESTSCHMIERSTOFF

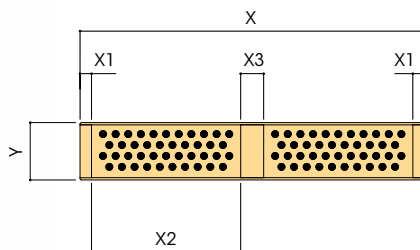

CODE	X	Y	Z	X1	X2	X3
S111001.120010020	1200	100	20	14	122	28
S111001.150010020	1500	100	20	14	122	28
S111001.030015020	300	150	20	14	122	28
S111001.060015020	600	150	20	14	122	28
S111001.105015020	1050	150	20	14	122	28
S111001.120015020	1200	150	20	14	122	28
S111001.150015020	1500	150	20	14	122	28

## S1.110.02

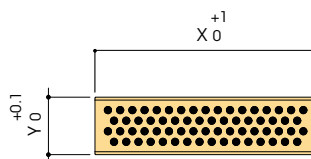

CODE	X	Y	Z
S111002.030502004	305	20	4
S111002.030503004	305	30	4
S111002.030502005	305	20	5
S111002.030502505	305	25	5
S111002.050002505	500	25	5
S111002.060502505	605	25	5
S111002.100502505	1005	25	5
S111002.030503005	305	30	5
S111002.040503005	405	30	5

CODE	X	Y	Z
S111002.030504005	305	40	5
S111002.060504005	605	40	5
S111002.030503006	305	30	6
S111002.040503006	405	30	6
S111002.060503006	605	30	6
S111002.100503006	1005	30	6
S111002.030504006	305	40	6
S111002.060504006	605	40	6
S111002.100504006	1005	40	6

## S1.1 PIASTRA GUIDA BRONZO AUTOLUBRIFICANTE

S1.1 WEAR PLATE SELF-LUBRICATING

S1.1 GLEITPLATTE BRONZE MIT FESTSCHMIERSTOFF

CODE	X	Y	Z
S111002.030503008	305	30	8
S111002.050503008	505	30	8
S111002.060503008	605	30	8
S111002.100503008	1005	30	8
S111002.030504008	305	40	8
S111002.050504008	505	40	8
S111002.060504008	605	40	8
S111002.100504008	1005	40	8
S111002.100505008	1005	50	8
S111002.060506008	605	60	8
S111002.100506008	1005	60	8
S111002.060502010	605	20	10
S111002.100502010	1005	20	10
S111002.015502510	155	25	10
S111002.030502510	305	25	10
S111002.060502510	605	25	10
S111002.100502510	1005	25	10
S111002.120502510	1205	25	10
S111002.030503010	305	30	10
S111002.060503010	605	30	10
S111002.100503010	1005	30	10
S111002.030503510	305	35	10
S111002.050003510	500	35	10
S111002.060503510	605	35	10
S111002.100503510	1005	35	10
S111002.015504010	155	40	10
S111002.030504010	305	40	10
S111002.050004010	500	40	10
S111002.060504010	605	40	10
S111002.100504010	1005	40	10
S111002.120504010	1205	40	10
S111002.015505010	155	50	10
S111002.030505010	305	50	10
S111002.050505010	505	50	10
S111002.060505010	605	50	10
S111002.100505010	1005	50	10
S111002.120505010	1205	50	10
S111002.060506010	605	60	10
S111002.100506010	1005	60	10
S111002.015506310	155	63	10
S111002.030506310	305	63	10
S111002.060506310	605	63	10
S111002.100506310	1005	63	10
S111002.120506310	1205	63	10
S111002.015507510	155	75	10
S111002.030507510	305	75	10

CODE	X	Y	Z
S111002.060507510	605	75	10
S111002.100507510	1005	75	10
S111002.120507510	1205	75	10
S111002.030508010	305	80	10
S111002.060508010	605	80	10
S111002.100508010	1005	80	10
S111002.015510010	155	100	10
S111002.030510010	305	100	10
S111002.050510010	505	100	10
S111002.060510010	605	100	10
S111002.100510010	1005	100	10
S111002.120510010	1205	100	10
S111002.015512510	155	125	10
S111002.030512510	305	125	10
S111002.060512510	605	125	10
S111002.100512510	1005	125	10
S111002.120512510	1205	125	10
S111002.015515010	155	150	10
S111002.030515010	305	150	10
S111002.060515010	605	150	10
S111002.100515010	1005	150	10
S111002.120515010	1205	150	10
S111002.100502012	1005	20	12
S111002.015502512	155	25	12
S111002.030502512	305	25	12
S111002.060502512	605	25	12
S111002.100502512	1005	25	12
S111002.120502512	1205	25	12
S111002.030503012	305	30	12
S111002.060503012	605	30	12
S111002.100503012	1005	30	12
S111002.015504012	155	40	12
S111002.030504012	305	40	12
S111002.050504012	505	40	12
S111002.060504012	605	40	12
S111002.100504012	1005	40	12
S111002.120504012	1205	40	12
S111002.015505012	155	50	12
S111002.030505012	305	50	12
S111002.050005012	500	50	12
S111002.060505012	605	50	12
S111002.100505012	1005	50	12
S111002.120505012	1205	50	12
S111002.060506012	605	60	12
S111002.100506012	1005	60	12
S111002.015506312	155	63	12

## S1.1 PIASTRA GUIDA BRONZO AUTOLUBRIFICANTE

S1.1 WEAR PLATE SELF-LUBRICATING

S1.1 GLEITPLATTE BRONZE MIT FESTSCHMIERSTOFF

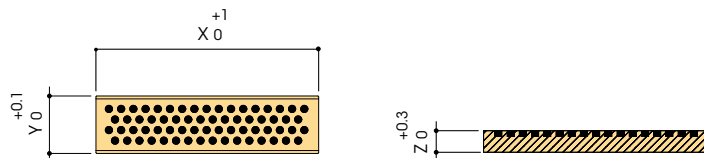

CODE	X	Y	Z
S111002.030506312	305	63	12
S111002.060506312	605	63	12
S111002.100506312	1005	63	12
S111002.120506312	1205	63	12
S111002.015507512	155	75	12
S111002.030507512	305	75	12
S111002.060507512	605	75	12
S111002.100507512	1005	75	12
S111002.120507512	1205	75	12
S111002.050508012	505	80	12
S111002.060508012	605	80	12
S111002.100508012	1005	80	12
S111002.015510012	155	100	12
S111002.030510012	305	100	12
S111002.060510012	605	100	12
S111002.100510012	1005	100	12
S111002.120510012	1205	100	12
S111002.015512512	155	125	12
S111002.030512512	305	125	12
S111002.060512512	605	125	12
S111002.100512512	1005	125	12
S111002.120512512	1205	125	12
S111002.015515012	155	150	12
S111002.030515012	305	150	12
S111002.060515012	605	150	12
S111002.100515012	1005	150	12
S111002.120515012	1205	150	12
S111002.015502515	155	25	15
S111002.030502515	305	25	15
S111002.060502515	605	25	15
S111002.100502515	1005	25	15
S111002.120502515	1205	25	15
S111002.015504015	155	40	15
S111002.030504015	305	40	15
S111002.060504015	605	40	15
S111002.100504015	1005	40	15
S111002.120504015	1205	40	15
S111002.015505015	155	50	15

CODE	X	Y	Z
S111002.030505015	305	50	15
S111002.060505015	605	50	15
S111002.100505015	1005	50	15
S111002.120505015	1205	50	15
S111002.060506015	605	60	15
S111002.015506315	155	63	15
S111002.030506315	305	63	15
S111002.060506315	605	63	15
S111002.100506315	1005	63	15
S111002.120506315	1205	63	15
S111002.015507515	155	75	15
S111002.030507515	305	75	15
S111002.060507515	605	75	15
S111002.100507515	1005	75	15
S111002.120507515	1205	75	15
S111002.060508015	605	80	15
S111002.015510015	155	100	15
S111002.030510015	305	100	15
S111002.060510015	605	100	15
S111002.100510015	1005	100	15
S111002.120510015	1205	100	15
S111002.015512515	155	125	15
S111002.030512515	305	125	15
S111002.060512515	605	125	15
S111002.100512515	1005	125	15
S111002.120512515	1205	125	15
S111002.015515015	155	150	15
S111002.030515015	305	150	15
S111002.060515015	605	150	15
S111002.100515015	1005	150	15
S111002.120515015	1205	150	15
S111002.050004016	500	40	16
S111002.060504016	605	40	16
S111002.100504016	1005	40	16
S111002.050006016	500	60	16
S111002.060506016	605	60	16
S111002.100506016	1005	60	16
S111002.050008016	500	80	16

## S1.1 PIASTRA GUIDA BRONZO AUTOLUBRIFICANTE

S1.1 WEAR PLATE SELF-LUBRICATING

S1.1 GLEITPLATTE BRONZE MIT FESTSCHMIERSTOFF

CODE	X	Y	Z
S111002.060508016	605	80	16
S111002.100508016	1005	80	16
S111002.060510016	605	100	16
S111002.100510016	1005	100	16
S111002.015502520	155	25	20
S111002.030502520	305	25	20
S111002.060502520	605	25	20
S111002.100502520	1005	25	20
S111002.120502520	1205	25	20
S111002.015504020	155	40	20
S111002.030504020	305	40	20
S111002.060504020	605	40	20
S111002.100504020	1005	40	20
S111002.120504020	1205	40	20
S111002.015505020	155	50	20
S111002.030505020	305	50	20
S111002.060505020	605	50	20
S111002.100505020	1005	50	20
S111002.120505020	1205	50	20
S111002.050506020	505	60	20
S111002.100506020	1005	60	20
S111002.015506320	155	63	20
S111002.030506320	305	63	20
S111002.060506320	605	63	20
S111002.100506320	1005	63	20
S111002.120506320	1205	63	20
S111002.015507520	155	75	20
S111002.030507520	305	75	20
S111002.060507520	605	75	20
S111002.100507520	1005	75	20

CODE	X	Y	Z
S111002.120507520	1205	75	20
S111002.050508020	505	80	20
S111002.060508020	605	80	20
S111002.100508020	1005	80	20
S111002.015510020	155	100	20
S111002.030510020	305	100	20
S111002.050010020	500	100	20
S111002.060510020	605	100	20
S111002.100510020	1005	100	20
S111002.120510020	1205	100	20
S111002.015512520	155	125	20
S111002.030512520	305	125	20
S111002.060512520	605	125	20
S111002.100512520	1005	125	20
S111002.120512520	1205	125	20
S111002.015515020	155	150	20
S111002.030515020	305	150	20
S111002.060515020	605	150	20
S111002.100515020	1005	150	20
S111002.120515020	1205	150	20
S111002.100516020	1005	160	20
S111002.060508025	605	80	25
S111002.100508025	1005	80	25
S111002.060510025	605	100	25
S111002.100510025	1005	100	25
S111002.060512525	605	125	25
S111002.100512525	1005	125	25
S111002.060516025	605	160	25
S111002.100516025	1005	160	25

## S1.1 PIASTRA GUIDA BRONZO AUTOLUBRIFICANTE

S1.1 WEAR PLATE SELF-LUBRICATING

S1.1 GLEITPLATTE BRONZE MIT FESTSCHMIERSTOFF

### S1.110.03

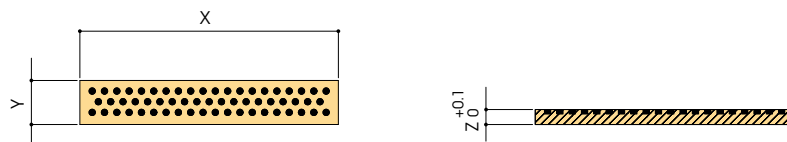

CODE	X	Y	Z
S111003.030502005	305	20	5,3
S111003.030502505	305	25	5,3
S111003.030503005	305	30	5,3
S111003.040003005	400	30	5,3

CODE	X	Y	Z
S111003.060503510	605	35	10,3
S111003.060504010	605	40	10,3
S111003.060505010	605	50	10,3
S111003.060506015	605	60	15,3

### S1.110.10

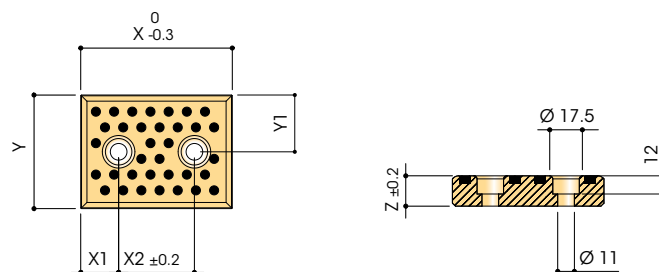

CODE	X	Y	Z	X1	X2	Y1
S111010.007502820	75	28	20	15	45	14
S111010.010002820	100	28	20	25	50	14
S111010.012502820	125	28	20	25	75	14
S111010.015002820	150	28	20	25	100	14
S111010.007503820	75	38	20	15	45	19
S111010.010003820	100	38	20	25	50	19
S111010.012503820	125	38	20	25	75	19
S111010.015003820	150	38	20	25	100	19
S111010.020003820	200	38	20	25	150	19
S111010.007504820	75	48	20	15	45	24
S111010.010004820	100	48	20	25	50	24
S111010.012504820	125	48	20	25	75	24
S111010.015004820	150	48	20	25	100	24
S111010.020004820	200	48	20	25	150	24
S111010.007505820	75	58	20	15	45	29
S111010.010005820	100	58	20	25	50	29
S111010.015005820	150	58	20	25	100	29
S111010.0075B7520	75	75	20	15	45	37,5
S111010.0100B7520	100	75	20	25	50	37,5
S111010.012507520	125	75	20	25	75	37,5
S111010.015007520	150	75	20	25	100	37,5
S111010.020007520	200	75	20	25	150	37,5



## S1.1 PIASTRA GUIDA BRONZO AUTOLUBRIFICANTE

S1.1 WEAR PLATE SELF-LUBRICATING

S1.1 Gleitplatte Bronze mit Festschmierstoff

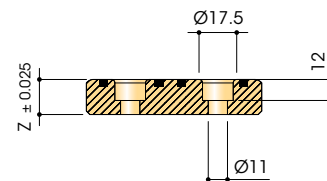
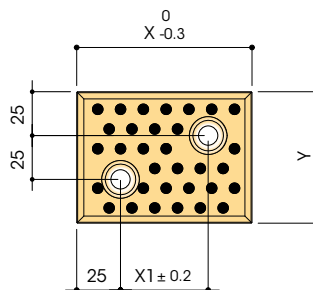

CODE	X	Y	Z	X1
S111010.007507520	75	75	20	25
S111010.010007520	100	75	20	50

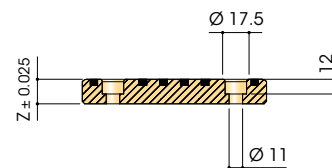
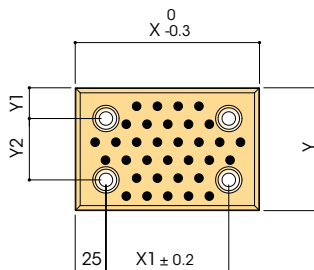

CODE	X	Y	Z	X1	Y1	Y2
S111010.010010020	100	100	20	50	25	50
S111010.012510020	125	100	20	75	25	50
S111010.015010020	150	100	20	100	25	50
S111010.020010020	200	100	20	150	25	50
S111010.025010020	250	100	20	200	25	50
S111010.030010020	300	100	20	250	25	50
S111010.012512520	125	125	20	75	37,5	50
S111010.015012520	150	125	20	100	37,5	50
S111010.020012520	200	125	20	150	37,5	50
S111010.025012520	250	125	20	200	37,5	50
S111010.030012520	300	125	20	250	37,5	50
S111010.035012520	350	125	20	300	37,5	50
S111010.015015020	150	150	20	100	25	100
S111010.020015020	200	150	20	150	25	100
S111010.025015020	250	150	20	200	25	100
S111010.030015020	300	150	20	250	25	100
S111010.020020020	200	200	20	150	25	150
S111010.025020020	250	200	20	200	25	150
S111010.030020020	300	200	20	250	25	150

## S1.1 PIASTRA GUIDA BRONZO AUTOLUBRIFICANTE

S1.1 WEAR PLATE SELF-LUBRICATING

S1.1 GLEITPLATTE BRONZE MIT FESTSCHMIERSTOFF

### S1.110.11

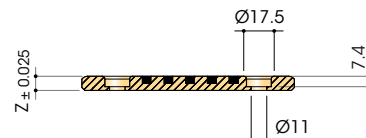
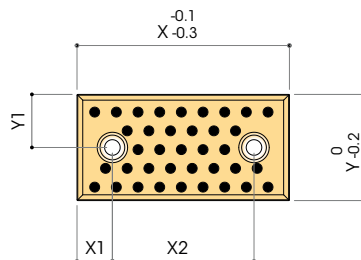

CODE	X	Y	Z	X1	X2	Y1
S111011.007502810	75	28	10	15	45	14
S111011.010002810	100	28	10	25	50	14
S111011.012502810	125	28	10	25	75	14
S111011.015002810	150	28	10	25	100	14
S111011.007503810	75	38	10	15	45	19
S111011.010003810	100	38	10	25	50	19
S111011.012503810	125	38	10	25	75	19
S111011.015003810	150	38	10	25	100	19
S111011.007504810	75	48	10	15	45	24
S111011.010004810	100	48	10	25	50	24
S111011.012504810	125	48	10	25	75	24
S111011.015004810	150	48	10	25	100	24
S111011.020004810	200	48	10	25	150	24
S111011.B20004810	200	48	10	50	100	24
S111011.007505810	75	58	10	15	45	29
S111011.010005810	100	58	10	25	50	29
S111011.012505810	125	58	10	25	75	29
S111011.015005810	150	58	10	25	100	29
S111011.020005810	200	58	10	50	100	29
S111011.007507510	75	75	10	15	45	37,5
S111011.010007510	100	75	10	25	50	37,5
S111011.012507510	125	75	10	25	75	37,5
S111011.015007510	150	75	10	25	100	37,5

## S1.1 PIASTRA GUIDA BRONZO AUTOLUBRIFICANTE

S1.1 WEAR PLATE SELF-LUBRICATING

S1.1 GLEITPLATTE BRONZE MIT FESTSCHMIERSTOFF

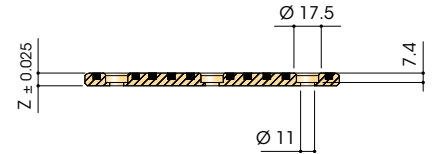
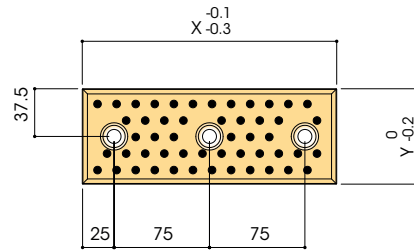

CODE	X	Y	Z
S111011.020007510	200	75	10

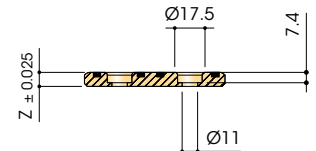
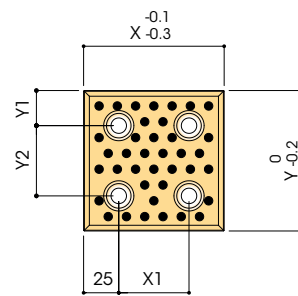
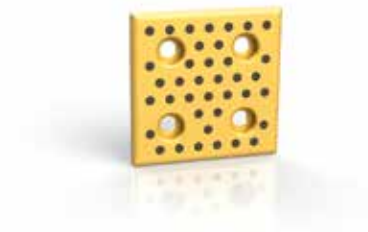

CODE	X	Y	Z	X1	Y1	Y2
S111011.010010010	100	100	10	50	25	50
S111011.012510010	125	100	10	75	25	50
S111011.015010010	150	100	10	100	25	50
S111011.020010010	200	100	10	150	25	50
S111011.025010010	250	100	10	200	25	50
S111011.015012510	150	125	10	100	37,5	50
S111011.020012510	200	125	10	150	37,5	50
S111011.025012510	250	125	10	200	37,5	50
S111011.015015010	150	150	10	100	25	100
S111011.020015010	200	150	10	150	25	100
S111011.025015010	250	150	10	200	25	100

## S1.1 PIASTRA GUIDA BRONZO AUTOLUBRIFICANTE

S1.1 WEAR PLATE SELF-LUBRICATING

S1.1 GLEITPLATTE BRONZE MIT FESTSCHMIERSTOFF

### S1.110.12

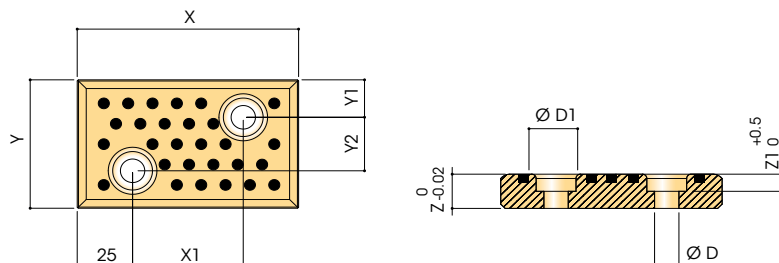

CODE	X	Y	Z	X1	Y1	Y2	D	D1	Z1
S111012.010006016	100	60	16	50	17,5	25	11	18	8
S111012.012506016	125	60	16	75	17,5	25	11	18	8
S111012.016006016	160	60	16	110	17,5	25	11	18	8
S111012.010008016	100	80	16	50	25	30	11	18	8
S111012.012508016	125	80	16	75	25	30	11	18	8
S111012.016008016	160	80	16	110	25	30	11	18	8
S111012.010008025	100	80	25	50	25	30	14	20	13
S111012.012508025	125	80	25	75	25	30	14	20	13
S111012.016008025	160	80	25	110	25	30	14	20	13
S111012.012510025	125	100	25	75	25	50	14	20	13
S111012.016010025	160	100	25	110	25	50	14	20	13
S111012.012512525	125	125	25	75	25	75	14	20	13

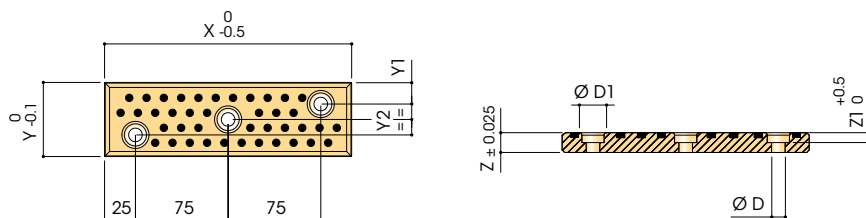

CODE	X	Y	Z	Y1	Y2	D	D1	Z1
S111012.020006016	200	60	16	17,5	12,5	8	18	8
S111012.020008016	200	80	16	25	15	8	18	8
S111012.020008025	200	80	25	25	15	13	20	13
S111012.020010025	200	100	25	25	25	13	20	13

## S1.1 PIASTRA GUIDA BRONZO AUTOLUBRIFICANTE

S1.1 WEAR PLATE SELF-LUBRICATING

S1.1 GLEITPLATTE BRONZE MIT FESTSCHMIERSTOFF

### S1.110.13

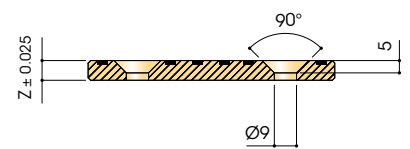
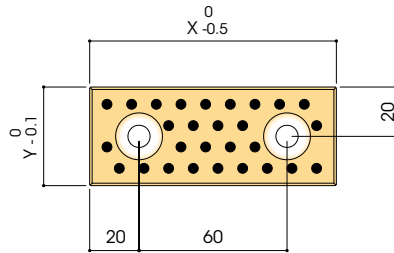

CODE	X	Y	Z
S111013.010004008	100	40	8

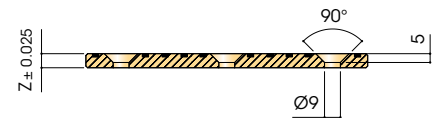
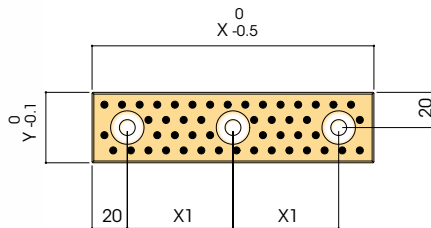

CODE	X	Y	Z	X1
S111013.016004008	160	40	8	60
S111013.025004008	250	40	8	105

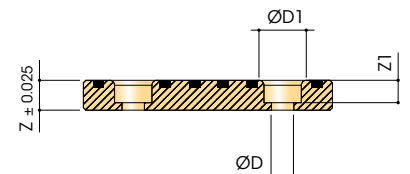
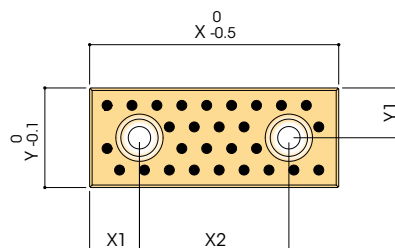

CODE	X	Y	Z	X1	X2	Y1	D	D1	Z1
S111013.010003012	100	30	12	20	60	15	9	15	9
S111013.010004012	100	40	12	20	60	20	9	15	9
S111013.010004016	100	40	16	20	60	20	11	18	11
S111013.024005020	240	50	20	50	140	25	13,5	20	13

## S1.1 PIASTRA GUIDA BRONZO AUTOLUBRIFICANTE

S1.1 WEAR PLATE SELF-LUBRICATING

S1.1 GLEITPLATTE BRONZE MIT FESTSCHMIERSTOFF

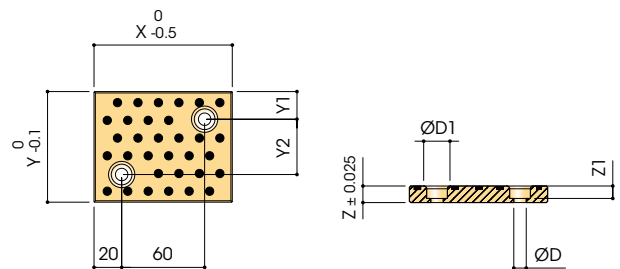

CODE	X	Y	Z	Y1	Y2	D	D1	Z1
S111013.010008012	100	80	12	20	40	9	15	9
S111013.010006016	100	60	16	15	30	11	18	11
S111013.010010016	100	100	16	20	60	11	18	11
S111013.010005020	100	50	20	15	20	13,5	20	13
S111013.010008020	100	80	20	20	40	13,5	20	13

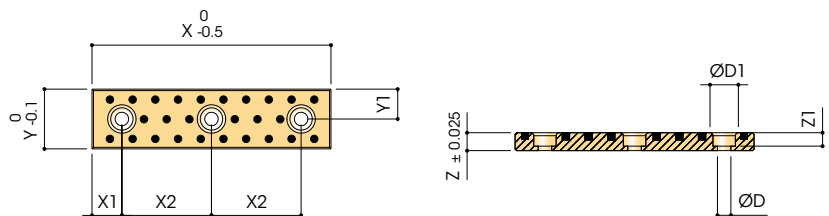

CODE	X	Y	Z	X1	X2	Y1	D	D1	Z1
S111013.016003012	160	30	12	20	60	15	9	15	9
S111013.024003012	240	30	12	25	95	15	9	15	9
S111013.025003012	250	30	12	20	105	15	9	15	9
S111013.016004012	160	40	12	20	60	20	9	15	9
S111013.025004012	250	40	12	20	105	20	9	15	9
S111013.016004016	160	40	16	20	60	20	11	18	11
S111013.025004016	250	40	16	20	105	20	11	18	11
S111013.030005020	300	50	20	50	100	25	13,5	20	13
S111013.035005020	350	50	20	50	125	25	13,5	20	13
S111013.030008020	300	80	20	50	100	40	13,5	20	13
S111013.035008020	350	80	20	50	125	40	13,5	20	13
S111013.040008020	400	80	20	50	150	40	13,5	20	13

## S1.1 PIASTRA GUIDA BRONZO AUTOLUBRIFICANTE

S1.1 WEAR PLATE SELF-LUBRICATING

S1.1 GLEITPLATTE BRONZE MIT FESTSCHMIERSTOFF

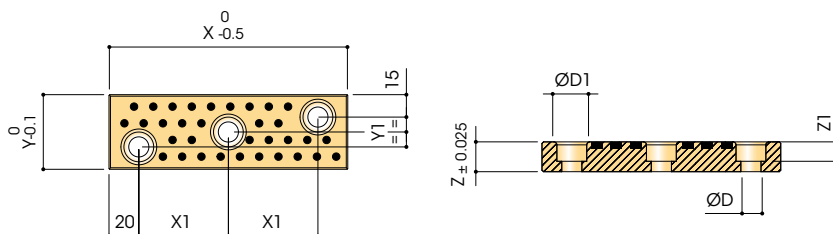

CODE	X	Y	Z	X1	Y1	D	D1	Z1
S111013.016006016	160	60	16	60	15	11	18	11
S111013.025006016	250	60	16	105	15	11	18	11
S111013.016005020	160	50	20	60	10	13,5	20	13
S111013.025005020	250	50	20	105	10	13,5	20	13

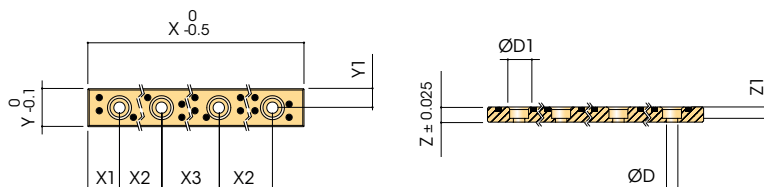

CODE	X	Y	Z	X1	X2	X3	Y1	D	D1	Z1
S111013.030003012	300	30	12	25	85	80	15	9	15	9
S111013.035003012	350	30	12	25	100	100	15	9	15	9
S111013.040003012	400	30	12	25	115	120	15	9	15	9
S111013.045008020	450	80	20	50	115	120	40	13,5	20	13
S111013.050008020	500	80	20	50	135	130	40	13,5	20	13

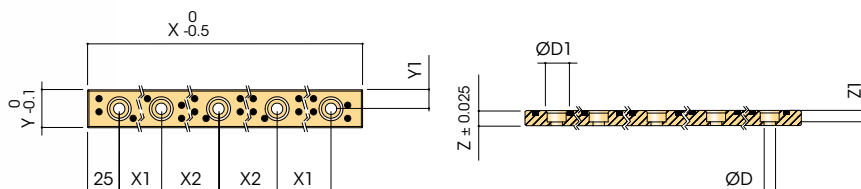

CODE	X	Y	Z	X1	X2
S111013.045003012	450	30	12	100	100
S111013.050003012	500	30	12	110	115

## S1.1 PIASTRA GUIDA BRONZO AUTOLUBRIFICANTE

S1.1 WEAR PLATE SELF-LUBRICATING

S1.1 GLEITPLATTE BRONZE MIT FESTSCHMIERSTOFF

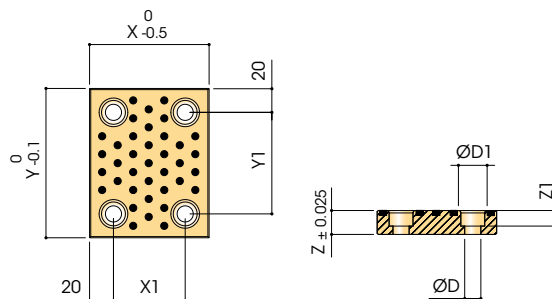

CODE	X	Y	Z	X1	Y1	D	D1	Z1
S111013.016008012	160	80	12	120	40	9	15	9
S111013.016010016	160	100	16	120	60	11	18	11
S111013.016008020	160	80	20	120	40	13,5	20	13
S111013.010012520	100	125	20	60	85	13,5	20	13
S111013.016012520	160	125	20	120	85	13,5	20	13

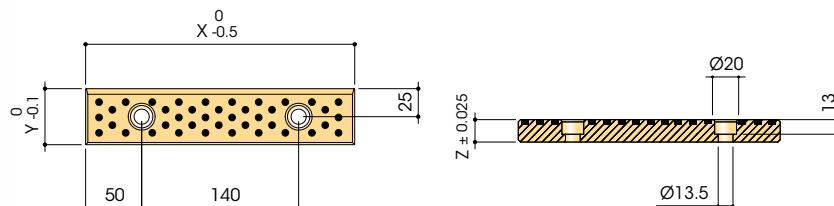

CODE	X	Y	Z
S111013.0240B5020	240	50	20

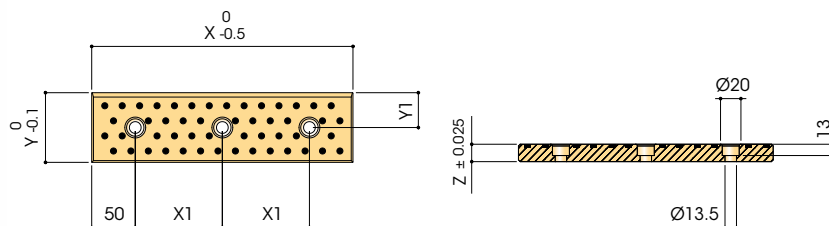

CODE	X	Y	Z	X1	Y1	CODE	X	Y	Z	X1	Y1
S111013.0300B5020	300	50	20	100	25	S111013.0300B8020	300	80	20	100	40
S111013.0350B5020	350	50	20	125	25	S111013.0350B8020	350	80	20	125	40
S111013.0400B5020	400	50	20	150	25	S111013.0400B8020	400	80	20	150	40



## S1.1 PIASTRA GUIDA BRONZO AUTOLUBRIFICANTE

S1.1 WEAR PLATE SELF-LUBRICATING

S1.1 Gleitplatte Bronze mit Festschmierstoff

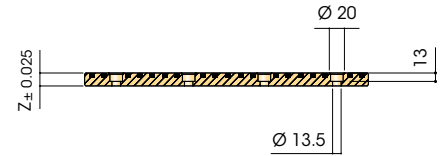
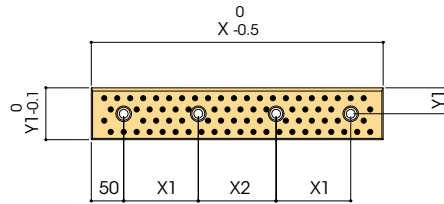

CODE	X	Y	Z	X1	X2	Y1
S111013.045005020	450	50	20	115	120	25
S111013.050005020	500	50	20	135	130	25
S111013.0450B8020	450	80	20	115	120	40
S111013.0500B8020	500	80	20	135	130	40

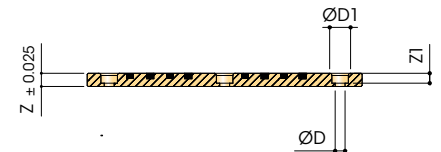
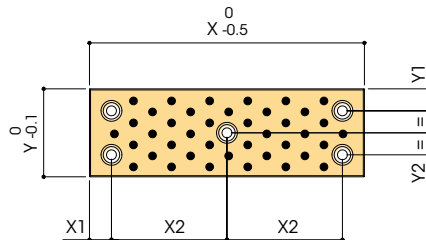

CODE	X	Y	Z	X1	X2	Y1	Y2	D	D1	Z1
S111013.025008012	250	80	12	20	105	20	20	9	15	9
S111013.025008020	250	80	20	20	105	20	20	13,5	20	13
S111013.040012520	400	125	20	50	150	25	37,5	13,5	20	13

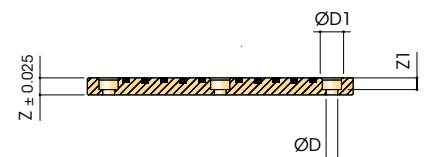
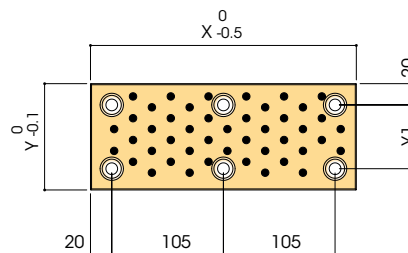

CODE	X	Y	Z	Y1	D	D1	Z1
S111013.025010016	250	100	16	60	11	18	11
S111013.025012520	250	125	20	85	13,5	20	13

## S1.1 PIASTRA GUIDA BRONZO AUTOLUBRIFICANTE

S1.1 WEAR PLATE SELF-LUBRICATING

S1.1 GLEITPLATTE BRONZE MIT FESTSCHMIERSTOFF

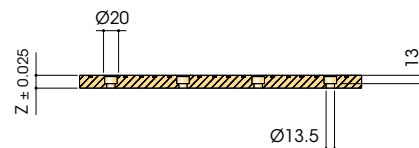
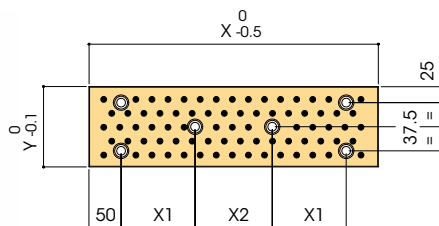

CODE	X	Y	Z	X1	X2
S111013.045012520	450	125	20	115	120
S111013.050012520	500	125	20	135	130

## S1.110.14

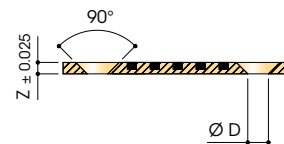
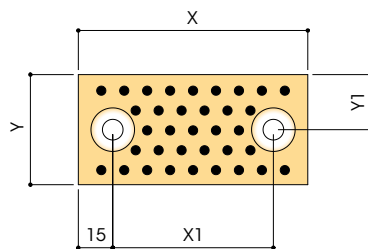

CODE	X	Y	Z	X1	Y1	D	Z1
S111014.005001805	50	18	5	20	9	6,6	3,5
S111014.007501805	75	18	5	45	9	6,6	5
S111014.010001805	100	18	5	70	9	6,6	5
S111014.005002805	50	28	5	20	14	9	5
S111014.007502805	75	28	5	45	14	9	5
S111014.010002805	100	28	5	70	14	9	5
S111014.005003805	50	38	5	20	19	9	5
S111014.007503805	75	38	5	45	19	9	5
S111014.010003805	100	38	5	70	19	9	5
S111014.007504805	75	48	5	45	24	9	5
S111014.010004805	100	48	5	70	24	9	5
S111014.012504805	125	48	5	95	24	9	5

## S1.1 PIASTRA GUIDA BRONZO AUTOLUBRIFICANTE

S1.1 WEAR PLATE SELF-LUBRICATING

S1.1 Gleitplatte Bronze mit Festschmierstoff

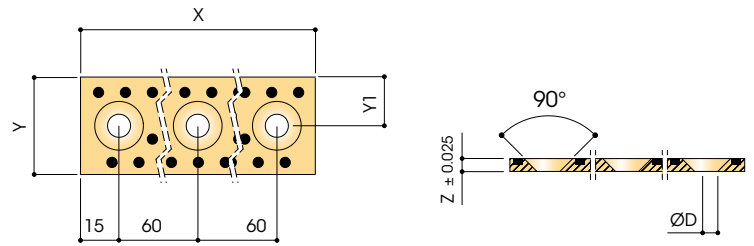

CODE	X	Y	Z	Y1	D
S111014.015001805	150	18	5	9	6,6
S111014.015002805	150	28	5	14	9

CODE	X	Y	Z	Y1	D
S111014.015003805	150	38	5	19	9
S111014.015004805	150	48	5	24	9

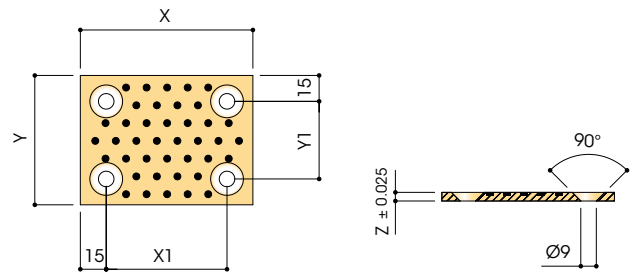
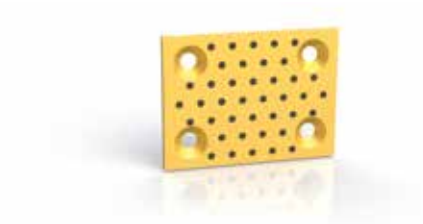

CODE	X	Y	Z	X1	Y1
S111014.007507505	75	75	5	45	45
S111014.010007505	100	75	5	70	45
S111014.012507505	125	75	5	95	45

CODE	X	Y	Z	X1	Y1
S111014.010010005	100	100	5	70	70
S111014.012510005	125	100	5	95	70

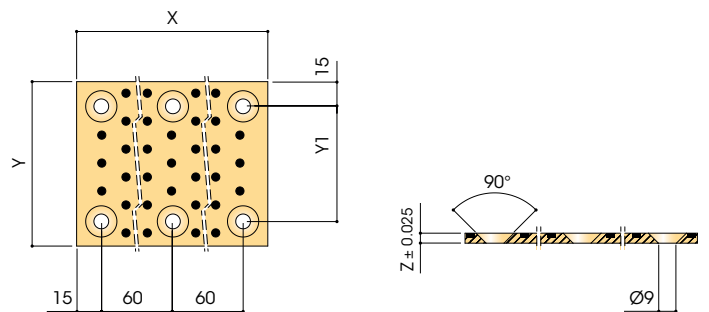
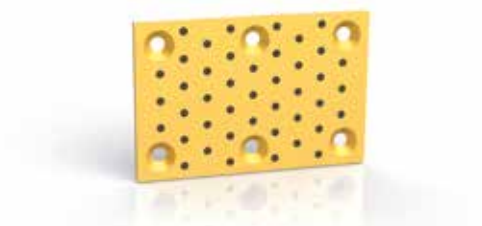

CODE	X	Y	Z	Y1
S111014.015007505	150	75	5	45
S111014.015010005	150	100	5	70

## S1.1 PIASTRA GUIDA BRONZO AUTOLUBRIFICANTE

S1.1 WEAR PLATE SELF-LUBRICATING

S1.1 GLEITPLATTE BRONZE MIT FESTSCHMIERSTOFF

### S1.110.15

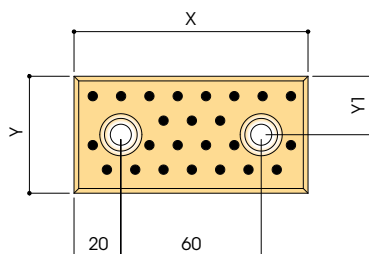
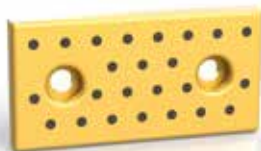

CODE	X	Y	Z	Y1
S111015.010003510	100	35	10	17,5
S111015.010005010	100	50	10	25

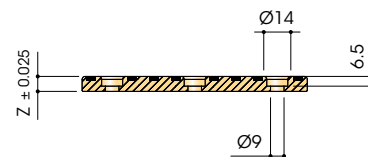
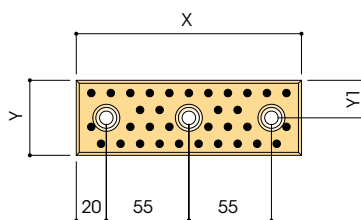

CODE	X	Y	Z	Y1
S111015.015003510	150	35	10	17,5
S111015.015005010	150	50	10	25

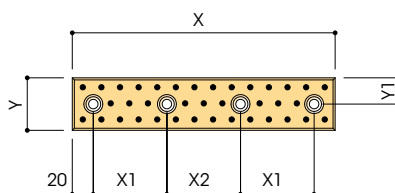

CODE	X	Y	Z	X1	X2	Y1
S111015.020003510	200	35	10	55	50	17,5
S111015.025003510	250	35	10	70	70	17,5
S111015.020005010	200	50	10	55	50	25
S111015.025005010	250	50	10	70	70	25

## S1.1 PIASTRA GUIDA BRONZO AUTOLUBRIFICANTE

S1.1 WEAR PLATE SELF-LUBRICATING

S1.1 GLEITPLATTE BRONZE MIT FESTSCHMIERSTOFF

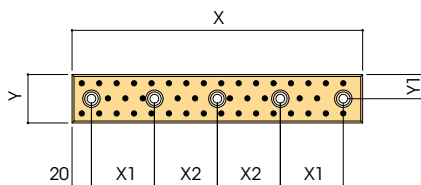

CODE	X	Y	Z	X1	X2	Y1
S111015.030003510	300	35	10	65	65	17,5
S111015.035003510	350	35	10	80	75	17,5
S111015.030005010	300	50	10	65	65	25
S111015.035005010	350	50	10	80	75	25
S111015.040005010	400	50	10	90	90	25

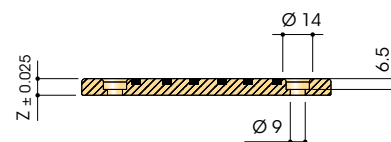
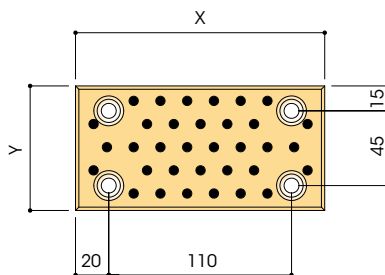

CODE	X	Y	Z
S111015.015007510	150	75	10

## S1.1 PIASTRA GUIDA BRONZO AUTOLUBRIFICANTE

S1.1 WEAR PLATE SELF-LUBRICATING

S1.1 GLEITPLATTE BRONZE MIT FESTSCHMIERSTOFF

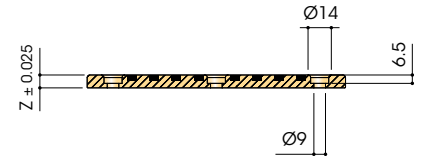
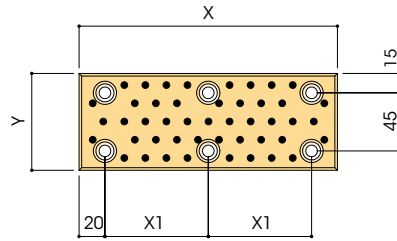

CODE	X	Y	Z	X1
S111015.020007510	200	75	10	80
S111015.025007510	250	75	10	105

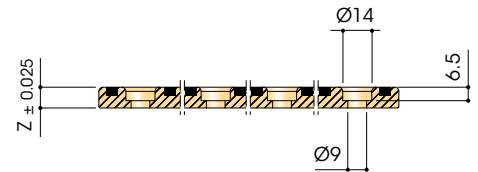
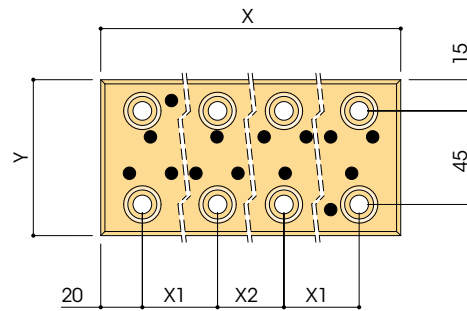

CODE	X	Y	Z	X1	X2
S111015.030007510	300	75	10	85	90
S111015.040007510	400	75	10	120	120

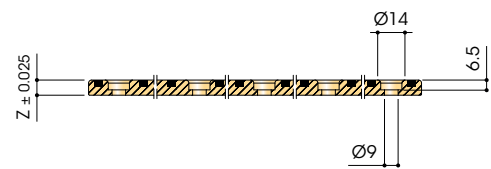
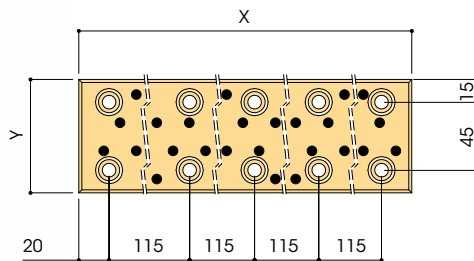

CODE	X	Y	Z
S111015.050007510	500	75	10

## S1.1 PIASTRA GUIDA BRONZO AUTOLUBRIFICANTE

S1.1 WEAR PLATE SELF-LUBRICATING

S1.1 GLEITPLATTE BRONZE MIT FESTSCHMIERSTOFF

### S1.110.16

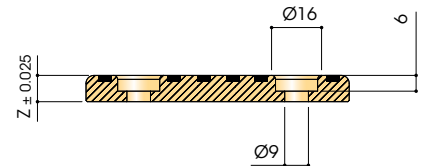
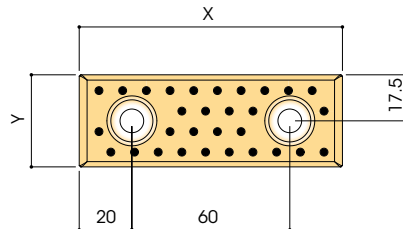

CODE	X	Y	Z
S111016.010003510	100	35	10

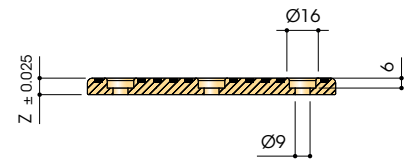
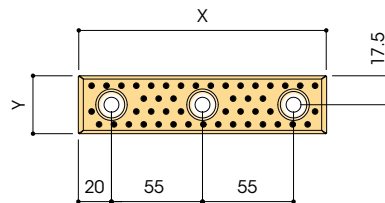

CODE	X	Y	Z
S111016.015003510	150	35	10

## S1.1 PIASTRA GUIDA BRONZO AUTOLUBRIFICANTE

S1.1 WEAR PLATE SELF-LUBRICATING

S1.1 GLEITPLATTE BRONZE MIT FESTSCHMIERSTOFF

### S1.110.17

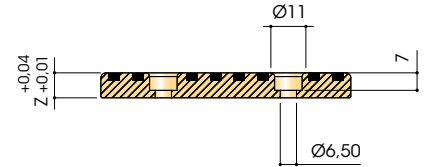
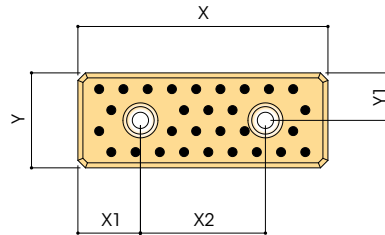

CODE	X	Y	Z	X1	X2	Y1
S111017.007501810	75	18	10	15	45	9
S111017.010001810	100	18	10	25	50	9
S111017.012501810	125	18	10	25	75	9
S111017.015001810	150	18	10	25	100	9
S111017.007502810	75	28	10	15	45	14
S111017.010002810	100	28	10	25	50	14
S111017.012502810	125	28	10	25	75	14
S111017.015002810	150	28	10	25	100	14
S111017.007503810	75	38	10	15	45	19
S111017.010003810	100	38	10	25	50	19
S111017.012503810	125	38	10	25	75	19
S111017.015003810	150	38	10	25	100	19
S111017.007504810	75	48	10	15	45	24
S111017.010004810	100	48	10	25	50	24
S111017.012504810	125	48	10	25	75	24
S111017.015004810	150	48	10	25	100	24



## S1.1 PIASTRA GUIDA BRONZO AUTOLUBRIFICANTE

S1.1 WEAR PLATE SELF-LUBRICATING

S1.1 Gleitplatte Bronze mit Festschmierstoff

### S1.110.18

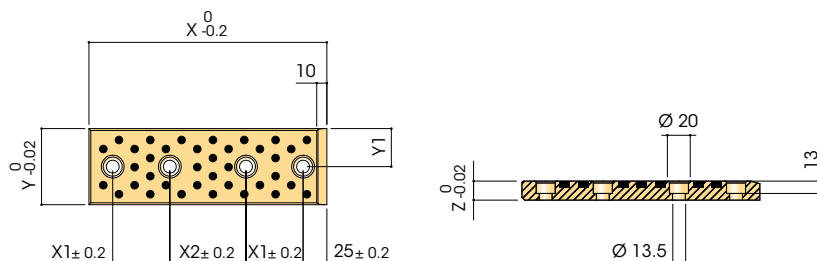

CODE	X	Y	Z	X1	X2	Y1
S111018.025005020	250	50	20	60	80	25
S111018.030005020	300	50	20	80	90	25
S111018.035005020	350	50	20	100	100	25
S111018.040005020	400	50	20	120	110	25
S111018.045005020	450	50	20	140	120	25
S111018.050005020	500	50	20	150	150	25
S111018.025008020	250	80	20	60	80	40
S111018.030008020	300	80	20	80	90	40
S111018.035008020	350	80	20	100	100	40
S111018.040008020	400	80	20	120	110	40
S111018.045008020	450	80	20	140	120	40
S111018.050008020	500	80	20	150	150	40
S111018.025010020	250	100	20	60	80	50
S111018.030010020	300	100	20	80	90	50
S111018.035010020	350	100	20	100	100	50
S111018.040010020	400	100	20	120	110	50
S111018.045010020	450	100	20	140	120	50
S111018.050010020	500	100	20	150	150	50
S111018.025012520	250	125	20	60	80	62,5
S111018.030012520	300	125	20	80	90	62,5
S111018.035012520	350	125	20	100	100	62,5
S111018.040012520	400	125	20	120	110	62,5
S111018.045012520	450	125	20	140	120	62,5
S111018.050012520	500	125	20	150	150	62,5
S111018.025016020	250	160	20	60	80	80
S111018.030016020	300	160	20	80	90	80
S111018.035016020	350	160	20	100	100	80
S111018.040016020	400	160	20	120	110	80
S111018.045016020	450	160	20	140	120	80
S111018.050016020	500	160	20	150	150	80

## S1.1 PIASTRA GUIDA BRONZO AUTOLUBRIFICANTE

S1.1 WEAR PLATE SELF-LUBRICATING

S1.1 GLEITPLATTE BRONZE MIT FESTSCHMIERSTOFF

### S1.110.19

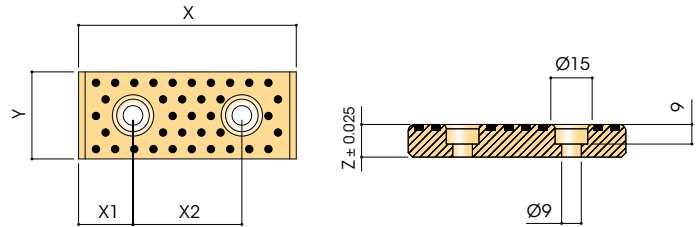

CODE	X	Y	Z	X1	X2	Y1
S111019.007504015	75	40	15	15	45	20
S111019.010004015	100	40	15	25	50	20
S111019.012504015	125	40	15	25	75	20
S111019.015004015	150	40	15	25	100	20
S111019.007506015	75	60	15	15	45	30
S111019.010006015	100	60	15	25	50	30
S111019.012506015	125	60	15	25	75	30
S111019.015006015	150	60	15	25	100	30

### S1.110.20

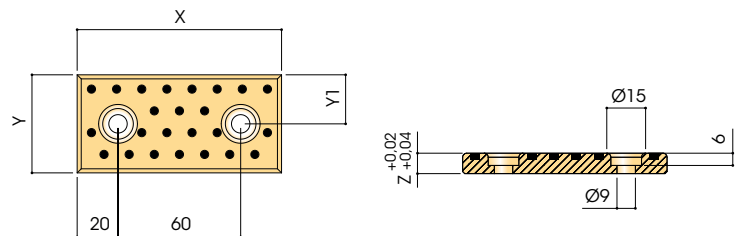

CODE	X	Y	Z	Y1	CODE	X	Y	Z	Y1
S111020.010001810	100	18	10	9	S111020.010003810	100	38	10	19
S111020.010002810	100	28	10	14	S111020.010004810	100	48	10	24

## S1.1 PIASTRA GUIDA BRONZO AUTOLUBRIFICANTE

S1.1 WEAR PLATE SELF-LUBRICATING

S1.1 Gleitplatte Bronze mit Festschmierstoff

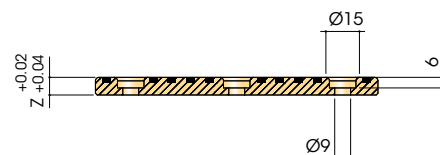
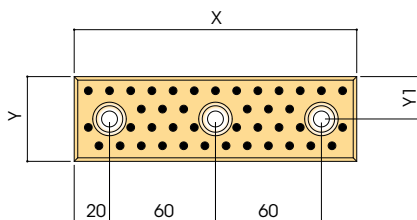

CODE	X	Y	Z	Y1
S111020.016001810	160	18	10	9
S111020.016002810	160	28	10	14

CODE	X	Y	Z	Y1
S111020.016003810	160	38	10	19
S111020.016004810	160	48	10	24

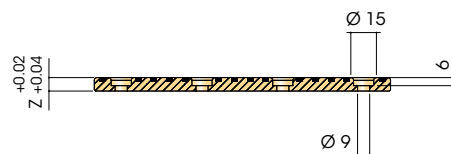
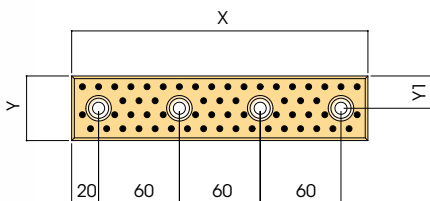

CODE	X	Y	Z	Y1
S111020.022001810	220	18	10	9
S111020.022002810	220	28	10	14

CODE	X	Y	Z	Y1
S111020.022003810	220	38	10	19
S111020.022004810	220	48	10	24

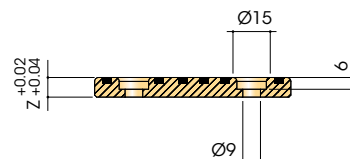
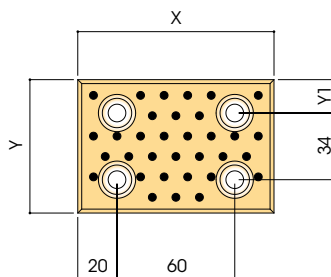

CODE	X	Y	Z	Y1
S111020.010005810	100	58	10	12
S111020.010006810	100	68	10	17

## S1.1 PIASTRA GUIDA BRONZO AUTOLUBRIFICANTE

S1.1 WEAR PLATE SELF-LUBRICATING

S1.1 GLEITPLATTE BRONZE MIT FESTSCHMIERSTOFF

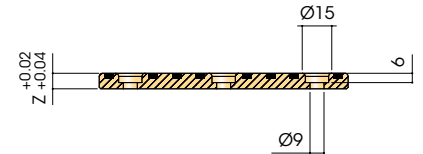
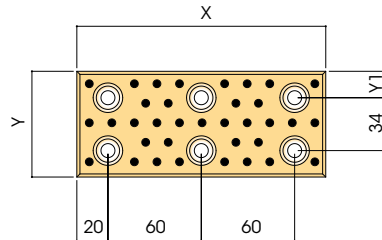

CODE	X	Y	Z	Y1
S111020.016005810	160	58	10	12
S111020.016006810	160	68	10	17

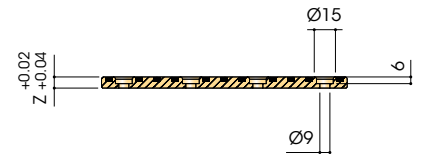
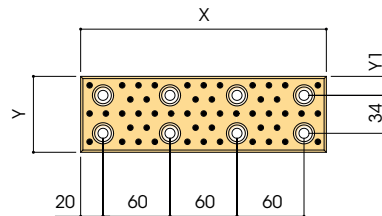

CODE	X	Y	Z	Y1
S111020.022005810	220	58	10	12
S111020.022006810	220	68	10	17

## S1.1 PIASTRA GUIDA BRONZO AUTOLUBRIFICANTE

S1.1 WEAR PLATE SELF-LUBRICATING

S1.1 GLEITPLATTE BRONZE MIT FESTSCHMIERSTOFF

### S1.110.21

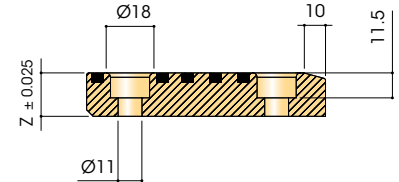
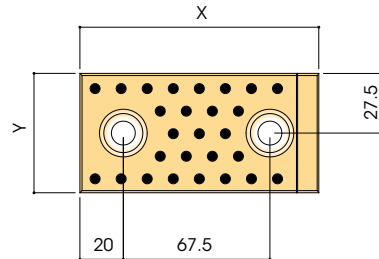

CODE	X	Y	Z
S111021.011005520	110	55	20

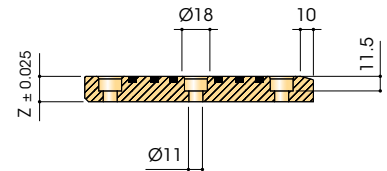
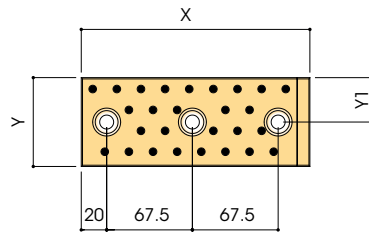

CODE	X	Y	Z	Y1
S111021.018005520	180	55	20	27
S111021.018007020	180	70	20	35

## S1.1 PIASTRA GUIDA BRONZO AUTOLUBRIFICANTE

S1.1 WEAR PLATE SELF-LUBRICATING

S1.1 GLEITPLATTE BRONZE MIT FESTSCHMIERSTOFF

### S1.110.30

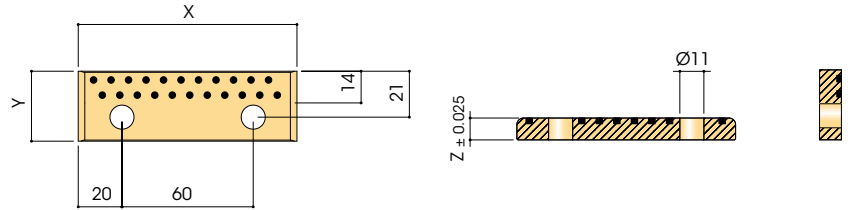

CODE	X	Y	Z
S111030.010003210	100	32	10

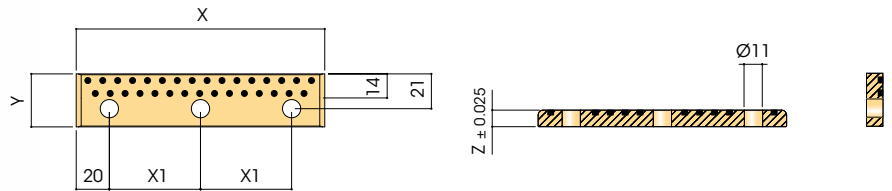

CODE	X	Y	Z	X1
S111030.015003210	150	32	10	55
S111030.016003210	160	32	10	60

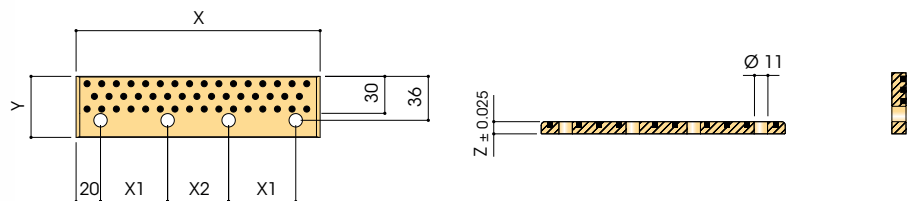

CODE	X	Y	Z	X1	X2
S111030.020005010	200	50	10	55	50
S111030.025005010	250	50	10	70	70

## S1.1 PIASTRA GUIDA BRONZO AUTOLUBRIFICANTE

S1.1 WEAR PLATE SELF-LUBRICATING

S1.1 GLEITPLATTE BRONZE MIT FESTSCHMIERSTOFF

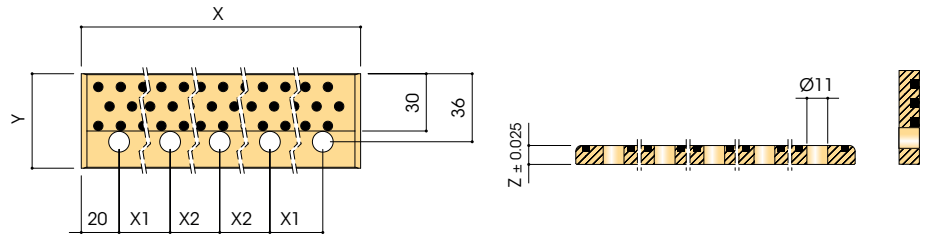

CODE	X	Y	Z	X1	X2
S111030.030005010	300	50	10	65	65
S111030.035005010	350	50	10	80	75
S111030.040005010	400	50	10	90	90

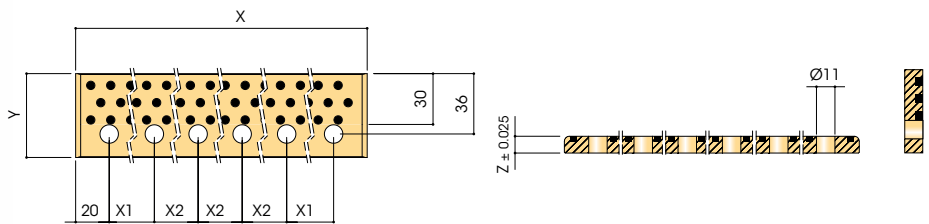

CODE	X	Y	Z	X1	X2
S111030.050005010	500	50	10	95	90
S111030.060005010	600	50	10	115	110

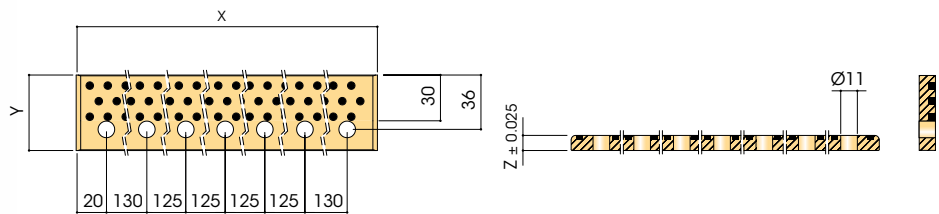

CODE	X	Y	Z
S111030.080005010	800	50	10

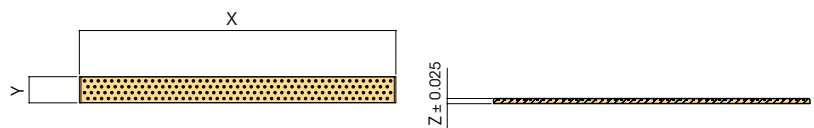

CODE	X	Y	Z
S111030.060505010	605	50	10
S111030.100505010	1005	50	10

## S1.1 PIASTRA GUIDA BRONZO AUTOLUBRIFICANTE

S1.1 WEAR PLATE SELF-LUBRICATING

S1.1 GLEITPLATTE BRONZE MIT FESTSCHMIERSTOFF

### S1.110.31

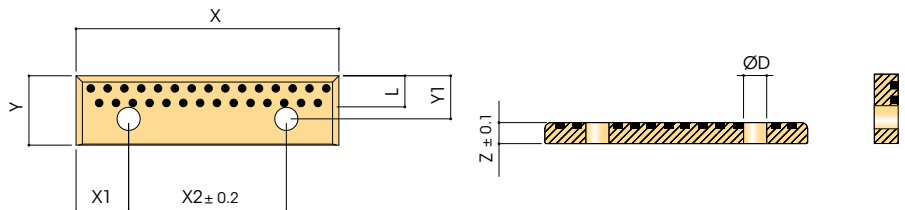

CODE	X	Y	Z	X1	X2	Y1	L	D
S111031.007502510	75	25	10	15	45	17	7,5	9
S111031.010002510	100	25	10	25	50	17	7,5	9
S111031.012502510	125	25	10	25	75	17	7,5	9
S111031.007503310	75	33	10	15	45	20,5	9	11
S111031.010003310	100	33	10	25	50	20,5	9	11
S111031.012503310	125	33	10	25	75	20,5	9	11
S111031.015003310	150	33	10	25	100	20,5	9	11
S111031.010005220	100	52	20	25	50	32	13	13
S111031.010007230	100	72	30	25	50	47	22	18

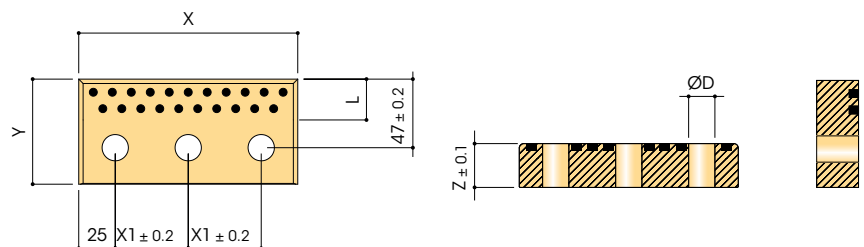

CODE	X	Y	Z	X1	Y1	L	D
S111031.020003310	200	33	10	75	20,5	9	11
S111031.015005220	150	52	20	50	32	12	13
S111031.020005220	200	52	20	75	32	12	13
S111031.015007230	150	72	30	50	47	22	18
S111031.020007230	200	72	30	75	47	22	18
S111031.015007735	150	77	35	50	52	27	18
S111031.020007735	200	77	35	75	52	27	18
S111031.015008240	150	82	40	50	57	32	18
S111031.020008240	200	82	40	75	57	32	18
S111031.015010540	150	105	40	50	80	32	18



## S1.1 PIASTRA GUIDA BRONZO AUTOLUBRIFICANTE

S1.1 WEAR PLATE SELF-LUBRICATING

S1.1 GLEITPLATTE BRONZE MIT FESTSCHMIERSTOFF

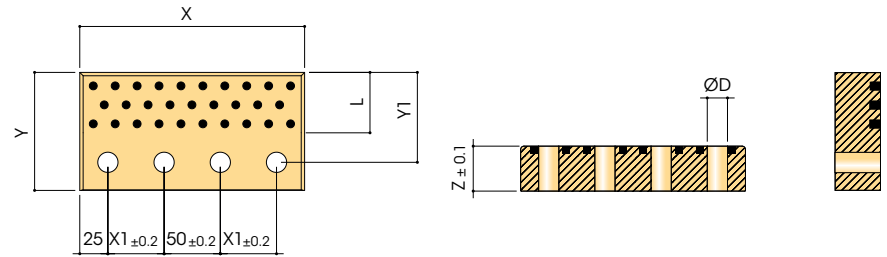
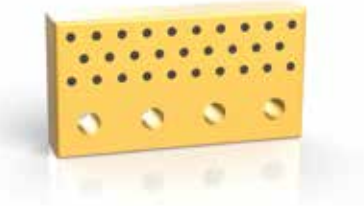

CODE	X	Y	Z	X1	Y1	L	D
S111031.025005220	250	52	20	75	32	12	13
S111031.025007230	250	72	30	75	47	22	18
S111031.025007735	250	77	35	75	52	27	18
S111031.025008240	250	82	40	75	57	32	18
S111031.020010540	200	105	40	50	80	32	18
S111031.025010540	250	105	40	75	80	32	18

## S1.1 PIASTRA GUIDA BRONZO AUTOLUBRIFICANTE

S1.1 WEAR PLATE SELF-LUBRICATING

S1.1 GLEITPLATTE BRONZE MIT FESTSCHMIERSTOFF

### S1.110.32

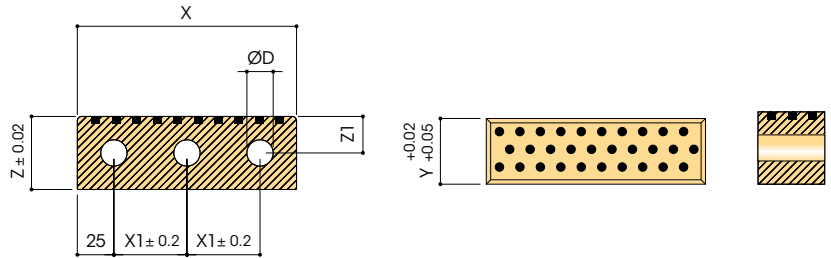

CODE	X	Y	Z	X1	Z1	D
S111032.015003040	150	30	40	50	20	14
S111032.020003040	200	30	40	75	20	14
S111032.015004040	150	40	40	50	20	14
S111032.020004040	200	40	40	75	20	14
S111032.015004550	150	45	50	50	25	18
S111032.020004550	200	45	50	75	25	18
S111032.015005550	150	55	50	50	25	18
S111032.020005550	200	55	50	75	25	18
S111032.015006050	150	60	50	50	25	18
S111032.020006050	200	60	50	75	25	18
S111032.015007050	150	70	50	50	25	18
S111032.020007050	200	70	50	75	25	18

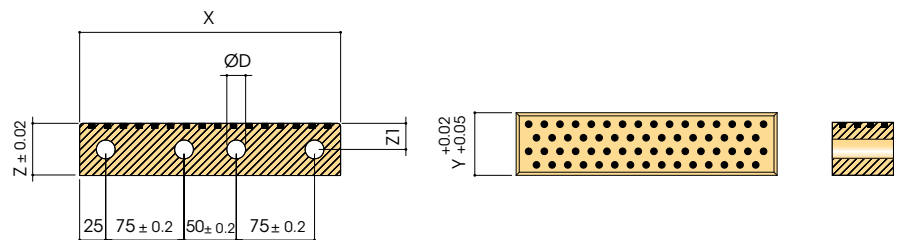

CODE	X	Y	Z	Z1	D	CODE	X	Y	Z	Z1	D
S111032.025003040	250	30	40	20	14	S111032.025005550	250	55	50	25	18
S111032.025004040	250	40	40	20	14	S111032.025006050	250	60	50	25	18
S111032.025004550	250	45	50	25	18	S111032.025007050	250	70	50	25	18

## S1.1 PIASTRA GUIDA BRONZO AUTOLUBRIFICANTE

S1.1 WEAR PLATE SELF-LUBRICATING

S1.1 GLEITPLATTE BRONZE MIT FESTSCHMIERSTOFF

### S1.110.33

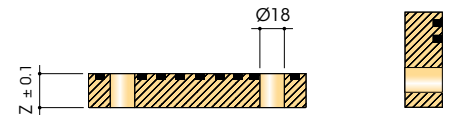
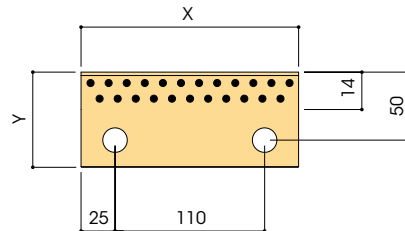

CODE	X	Y	Z
S111033.016007025	160	70	25

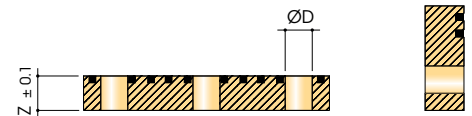
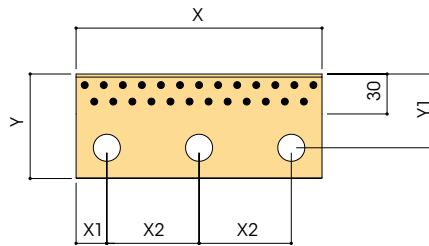

CODE	X	Y	Z	X1	X2	Y1	D
S111033.020007025	200	70	25	25	75	50	18
S111033.024007025	240	70	25	30	90	50	18
S111033.020008528	200	85	28	25	75	60	22
S111033.024008528	240	85	28	30	90	60	22

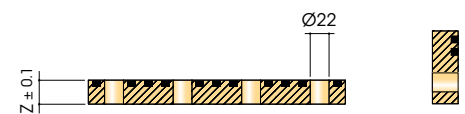
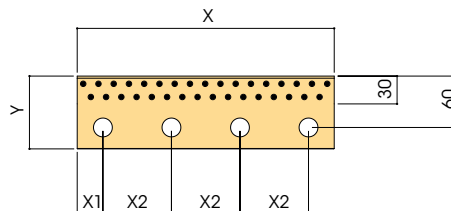

CODE	X	Y	Z	X1	X2
S111033.030008528	300	85	28	30	80
S111033.035008528	350	85	28	40	90

## S1.1 PIASTRA GUIDA BRONZO AUTOLUBRIFICANTE

S1.1 WEAR PLATE SELF-LUBRICATING

S1.1 GLEITPLATTE BRONZE MIT FESTSCHMIERSTOFF

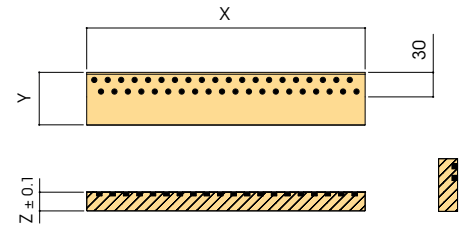

CODE	X	Y	Z
S111033.060507025	605	70	25
S111033.060508528	605	85	28
S111033.100508528	1005	85	28

## S1.112.10

ISO 9183

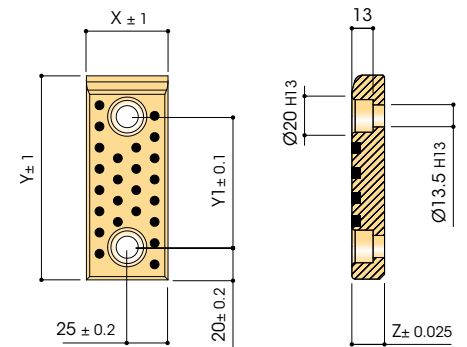

CODE	X	Y	Z	X1
S111210.005008020	50	80	20	35
S111210.005010020	50	100	20	55
S111210.005012520	50	125	20	80

CODE	X	Y	Z	X1
S111210.005016020	50	160	20	115
S111210.005020020	50	200	20	155

## S1.1 PIASTRA GUIDA BRONZO AUTOLUBRIFICANTE

S1.1 WEAR PLATE SELF-LUBRICATING

S1.1 GLEITPLATTE BRONZE MIT FESTSCHMIERSTOFF

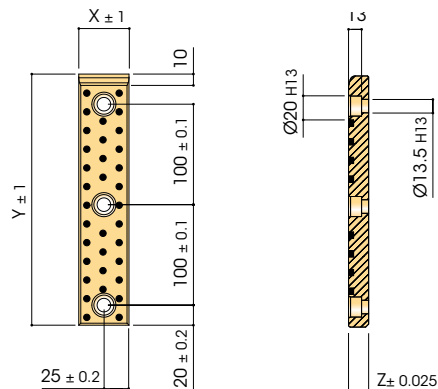

CODE	X	Y	Z
S111210.005025020	50	250	20

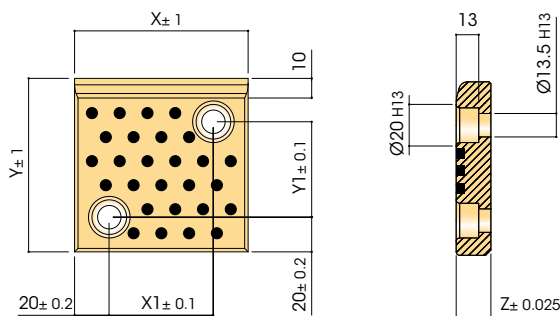

CODE	X	Y	Z	X1	Y1
S111210.008008020	80	80	20	40	35
S111210.010008020	100	80	20	60	35
S111210.012508020	125	80	20	85	35

CODE	X	Y	Z	X1	Y1
S111210.008010020	80	100	20	40	55
S111210.010010020	100	100	20	60	55
S111210.008012520	80	125	20	40	80

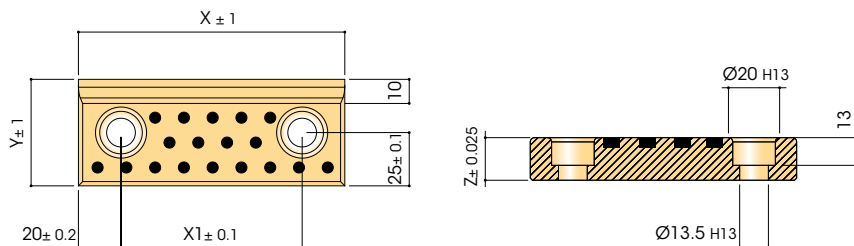

CODE	X	Y	Z	X1
S111210.008005020	80	50	20	40
S111210.010005020	100	50	20	60

CODE	X	Y	Z	X1
S111210.012505020	125	50	20	85
S111210.016005020	160	50	20	120

## S1.1 PIASTRA GUIDA BRONZO AUTOLUBRIFICANTE

S1.1 WEAR PLATE SELF-LUBRICATING

S1.1 GLEITPLATTE BRONZE MIT FESTSCHMIERSTOFF

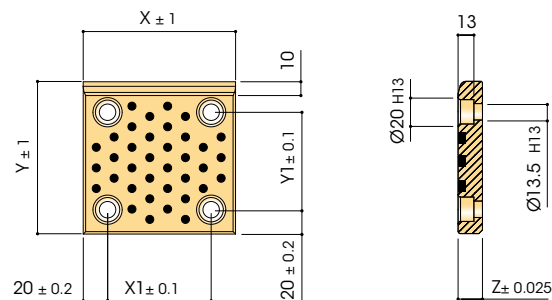

CODE	X	Y	Z	X1	Y1
S111210.016008020	160	80	20	120	35
S111210.012510020	125	100	20	85	55
S111210.016010020	160	100	20	120	55
S111210.010012520	100	125	20	60	80
S111210.012512520	125	125	20	85	80
S111210.016012520	160	125	20	120	80
S111210.008016020	80	160	20	40	115
S111210.010016020	100	160	20	60	115

CODE	X	Y	Z	X1	Y1
S111210.012516020	125	160	20	85	115
S111210.016016020	160	160	20	120	115
S111210.020016020	200	160	20	160	115
S111210.008020020	80	200	20	40	155
S111210.010020020	100	200	20	60	155
S111210.012520020	125	200	20	85	155
S111210.016020020	160	200	20	120	155
S111210.020020020	200	200	20	160	155

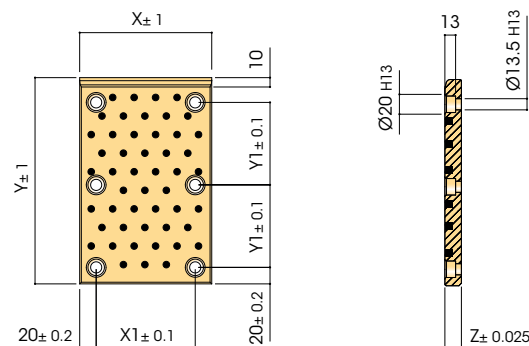

CODE	X	Y	Z	X1	Y1
S111210.008025020	80	250	20	40	100
S111210.010025020	100	250	20	60	100
S111210.012525020	125	250	20	85	100
S111210.016025020	160	250	20	120	100

CODE	X	Y	Z	X1	Y1
S111210.008031520	80	315	20	40	132
S111210.010031520	100	315	20	60	132
S111210.012531520	125	315	20	85	132
S111210.016031520	160	315	20	120	132

## S1.1 PIASTRA GUIDA BRONZO AUTOLUBRIFICANTE

S1.1 WEAR PLATE SELF-LUBRICATING

S1.1 Gleitplatte Bronze mit Festschmierstoff

### S1.112.11

ISO 9183

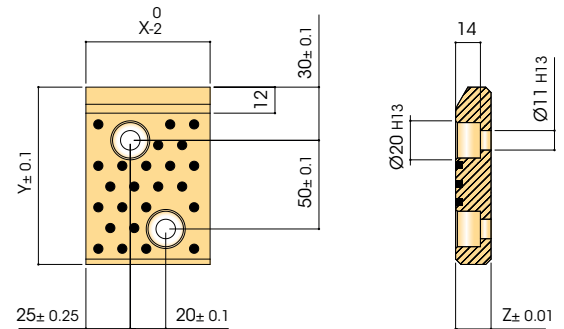

CODE	X	Y	Z
S111211.007010020	70	100	20

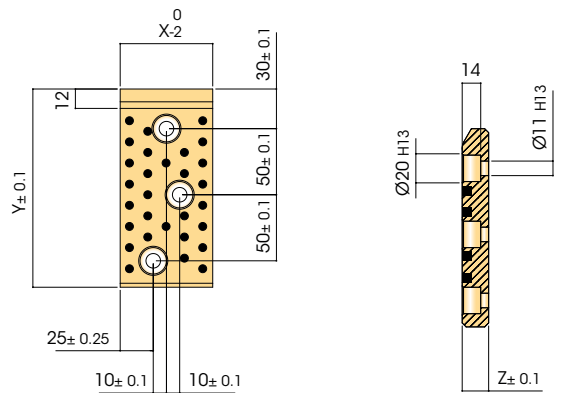

CODE	X	Y	Z
S111211.007015020	70	150	20

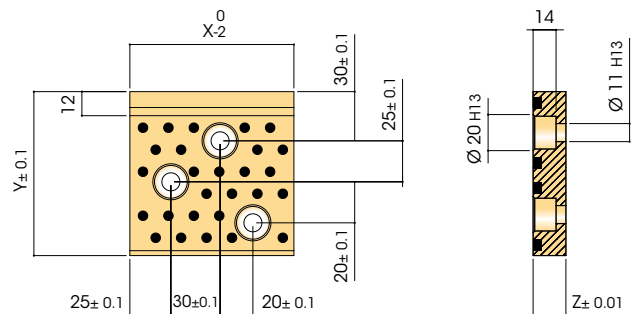

CODE	X	Y	Z
S111211.010010020	100	100	20

**S1.1 PIASTRA GUIDA BRONZO AUTOLUBRIFICANTE**

**S1.1 WEAR PLATE SELF-LUBRICATING**

**S1.1 GLEITPLATTE BRONZE MIT FESTSCHMIERSTOFF**

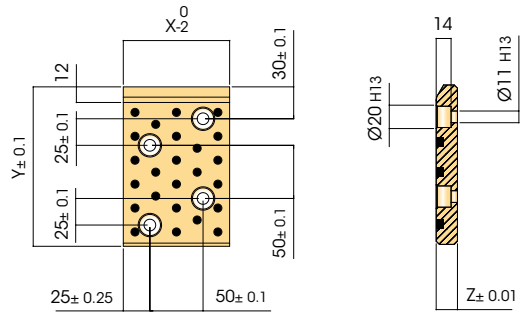

CODE	X	Y	Z
S111211.010015020	100	150	20

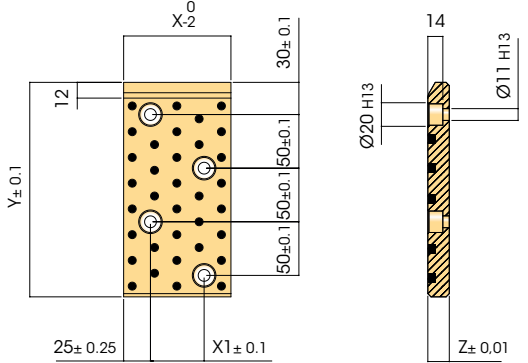

CODE	X	Y	Z	X1
S111211.007020020	70	200	20	20
S111211.010020020	100	200	20	50
S111211.015020020	150	200	20	100

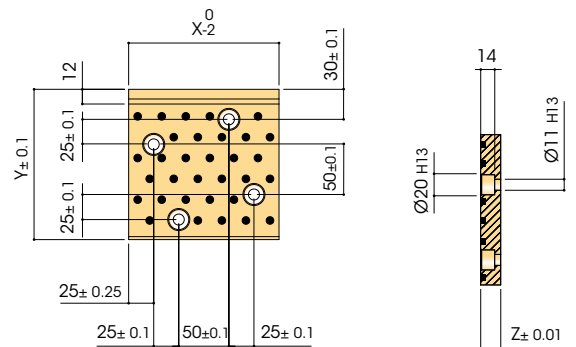

CODE	X	Y	Z
S111211.015015020	150	150	20



## S1.1 PIASTRA GUIDA BRONZO AUTOLUBRIFICANTE

S1.1 WEAR PLATE SELF-LUBRICATING

S1.1 GLEITPLATTE BRONZE MIT FESTSCHMIERSTOFF

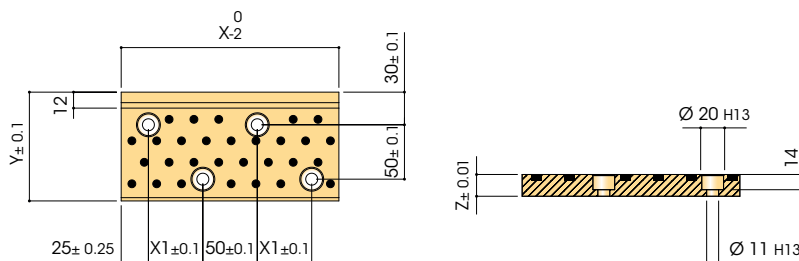
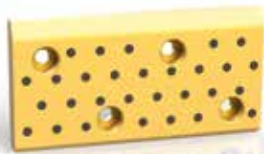

CODE	X	Y	Z	X1
S111211.015010020	150	100	20	25
S111211.020010020	200	100	20	50

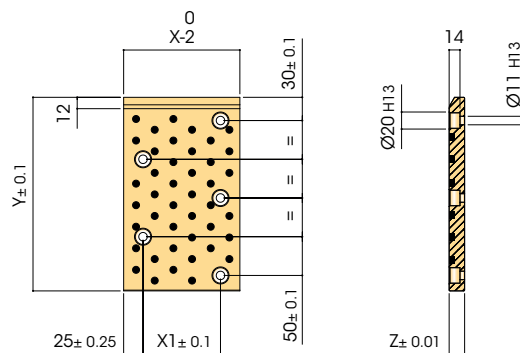

CODE	X	Y	Z	X1
S111211.010025020	100	250	20	50
S111211.015025020	150	250	20	100

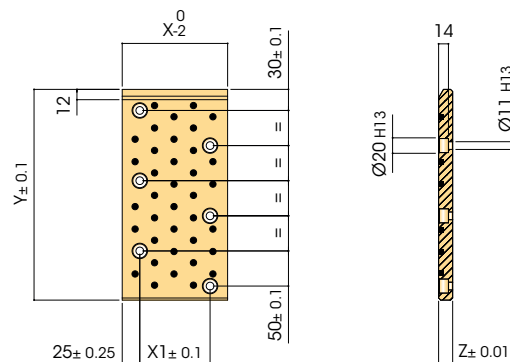
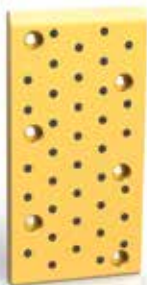

CODE	X	Y	Z	X1
S111211.010030020	100	300	20	50
S111211.015030020	150	300	20	100

## S1.1 PIASTRA GUIDA BRONZO AUTOLUBRIFICANTE

S1.1 WEAR PLATE SELF-LUBRICATING

S1.1 GLEITPLATTE BRONZE MIT FESTSCHMIERSTOFF

### S1.113.10

VDI

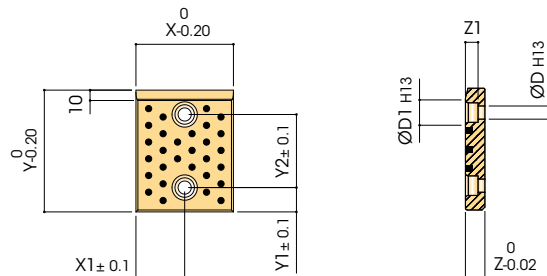

CODE	X	Y	Z	X1	Y1	Y2	D	D1	Z1
<a href="#">S111310.005008020</a>	50	80	20	25	25	30	9	15	9
<a href="#">S111310.008008020</a>	80	80	20	40	25	30	13,5	20	13
<a href="#">S111310.005010020</a>	50	100	20	25	25	50	13,5	20	13
<a href="#">S111310.008010020</a>	80	100	20	40	25	50	13,5	20	13
<a href="#">S111310.010010020</a>	100	100	20	50	25	50	13,5	20	13
<a href="#">S111310.005012520</a>	50	125	20	25	25	75	13,5	20	13
<a href="#">S111310.008012520</a>	80	125	20	40	25	75	13,5	20	13
<a href="#">S111310.010012520</a>	100	125	20	50	25	75	13,5	20	13
<a href="#">S111310.005016020</a>	50	160	20	25	25	110	13,5	20	13
<a href="#">S111310.008016020</a>	80	160	20	40	25	110	13,5	20	13
<a href="#">S111310.010016020</a>	100	160	20	50	25	110	13,5	20	13
<a href="#">S111310.005020020</a>	50	200	20	25	25	150	13,5	20	13
<a href="#">S111310.008020020</a>	80	200	20	40	25	150	13,5	20	13
<a href="#">S111310.010020020</a>	100	200	20	50	25	150	13,5	20	13
<a href="#">S111310.008025020</a>	80	250	20	40	40	170	13,5	20	13
<a href="#">S111310.010025020</a>	100	250	20	50	40	170	13,5	20	13
<a href="#">S111310.008031520</a>	80	315	20	40	40	235	13,5	20	13
<a href="#">S111310.010031520</a>	100	315	20	50	40	235	13,5	20	13

## S1.1 PIASTRA GUIDA BRONZO AUTOLUBRIFICANTE

S1.1 WEAR PLATE SELF-LUBRICATING

S1.1 Gleitplatte Bronze mit Festschmierstoff

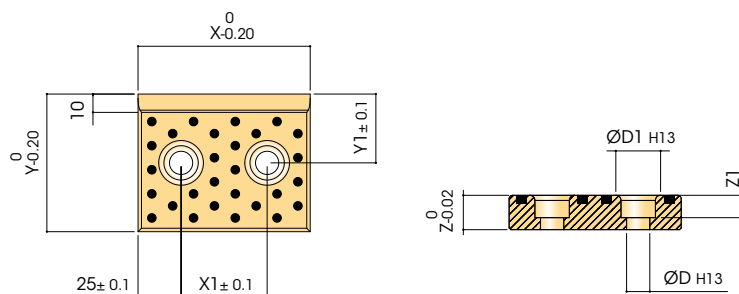

CODE	X	Y	Z	X1	Y1	D	D1	Z1
S111310.008005020	80	50	20	30	25	9	15	9
S111310.010005020	100	50	20	50	25	13,5	20	13
S111310.012505020	125	50	20	75	25	13,5	20	13
S111310.016005020	160	50	20	110	25	13,5	20	13
S111310.010008020	100	80	20	50	40	13,5	20	13
S111310.012508020	125	80	20	75	40	13,5	20	13
S111310.016008020	160	80	20	110	40	13,5	20	13

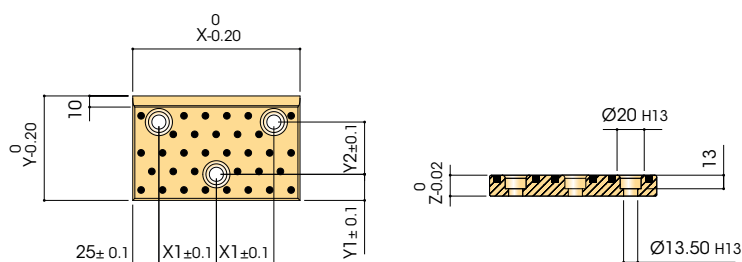

CODE	X	Y	Z	X1	Y1	Y2
S111310.012510020	125	100	20	37,5	25	50
S111310.016010020	160	100	20	55	25	50
S111310.012512520	125	125	20	37,5	25	75
S111310.016012520	160	125	20	55	25	75
S111310.012516020	125	160	20	37,5	25	110
S111310.016016020	160	160	20	55	25	110
S111310.012520020	125	200	20	37,5	25	150
S111310.016020020	160	200	20	55	25	150
S111310.012525020	125	250	20	37,5	40	170
S111310.012531520	125	315	20	37,5	40	235

## S1.1 PIASTRA GUIDA BRONZO AUTOLUBRIFICANTE

S1.1 WEAR PLATE SELF-LUBRICATING

S1.1 GLEITPLATTE BRONZE MIT FESTSCHMIERSTOFF

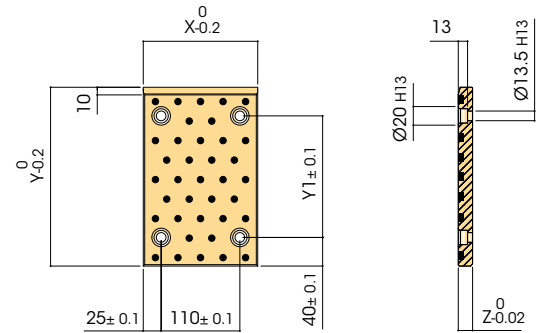

CODE	X	Y	Z	Y1
S111310.016025020	160	250	20	170
S111310.016031520	160	315	20	235

## S1.113.11

VDI

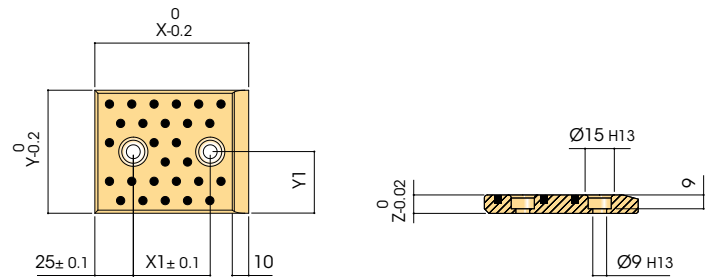

CODE	X	Y	Z	X1	Y1
S111311.016002512	160	25	12	110	12,5
S111311.020002512	200	25	12	150	12,5
S111311.008003012	80	30	12	30	15
S111311.010003012	100	30	12	50	15
S111311.012503012	125	30	12	75	15
S111311.016003012	160	30	12	110	15
S111311.020003012	200	30	12	150	15
S111311.022503012	225	30	12	175	15
S111311.008004012	80	40	12	30	20
S111311.010004012	100	40	12	50	20
S111311.012504012	125	40	12	75	20
S111311.016004012	160	40	12	110	20
S111311.020004012	200	40	12	150	20
S111311.008005012	80	50	12	30	25
S111311.010005012	100	50	12	50	25
S111311.012505012	125	50	12	75	25

CODE	X	Y	Z	X1	Y1
S111311.016005012	160	50	12	110	25
S111311.020005012	200	50	12	150	25
S111311.022505012	225	50	12	175	25
S111311.008006012	80	60	12	30	30
S111311.010006012	100	60	12	50	30
S111311.012506012	125	60	12	75	30
S111311.016006012	160	60	12	110	30
S111311.020006012	200	60	12	150	30
S111311.022506012	225	60	12	175	30
S111311.008008012	80	80	12	30	40
S111311.010008012	100	80	12	50	40
S111311.012508012	125	80	12	75	40
S111311.016008012	160	80	12	110	40
S111311.020008012	200	80	12	150	40
S111311.022508012	225	80	12	175	40

## S1.1 PIASTRA GUIDA BRONZO AUTOLUBRIFICANTE

S1.1 WEAR PLATE SELF-LUBRICATING

S1.1 GLEITPLATTE BRONZE MIT FESTSCHMIERSTOFF

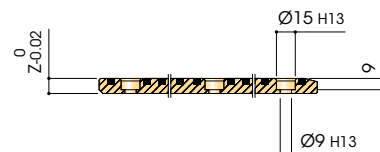
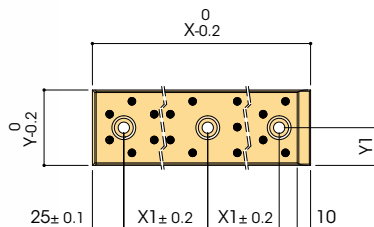

CODE	X	Y	Z	X1	Y1
S111311.025002512	250	25	12	100	12,5
S111311.030006012	300	60	12	125	30

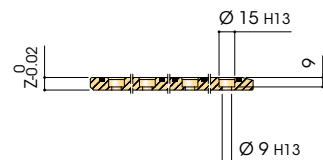
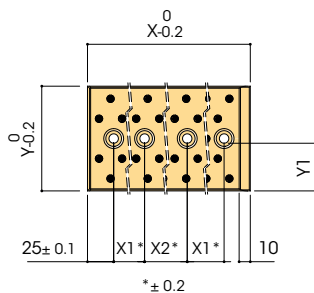

CODE	X	Y	Z	X1	X2	Y1
S111311.025003012	250	30	12	60	80	15
S111311.026003012	260	30	12	60	90	15
S111311.028003012	280	30	12	60	110	15
S111311.030003012	300	30	12	80	90	15
S111311.032003012	320	30	12	80	110	15
S111311.025005012	250	50	12	60	80	25
S111311.030005012	300	50	12	80	90	25
S111311.035005012	350	50	12	100	100	25
S111311.040005012	400	50	12	120	110	25
S111311.024006012	240	60	12	60	70	30
S111311.025006012	250	60	12	60	80	30
S111311.026006012	260	60	12	60	90	30
S111311.028006012	280	60	12	60	110	30
S111311.024008012	240	80	12	60	70	40
S111311.025008012	250	80	12	60	80	40
S111311.026008012	260	80	12	60	90	40
S111311.028008012	280	80	12	60	110	40
S111311.024010012	240	100	12	60	70	50
S111311.026010012	260	100	12	60	90	50
S111311.028010012	280	100	12	60	110	50

## S1.1 PIASTRA GUIDA BRONZO AUTOLUBRIFICANTE

S1.1 WEAR PLATE SELF-LUBRICATING

S1.1 GLEITPLATTE BRONZE MIT FESTSCHMIERSTOFF

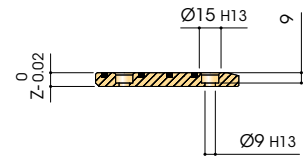
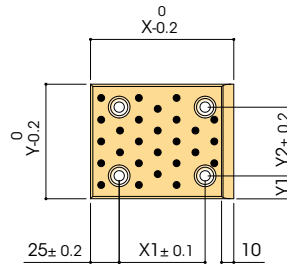

CODE	X	Y	Z	X1	Y1	Y2
S111311.012510012	125	100	12	75	25	50
S111311.016010012	160	100	12	110	25	50
S111311.020010012	200	100	12	150	25	50
S111311.025010012	250	100	12	200	25	50
S111311.016012512	160	125	12	110	20	85
S111311.016015012	160	150	12	110	20	110
S111311.016016012	160	160	12	110	20	120

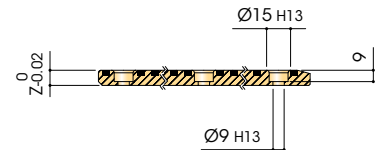
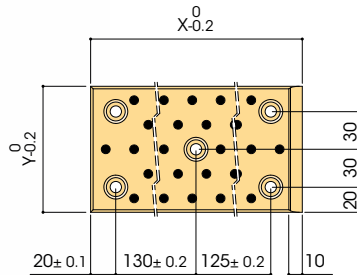
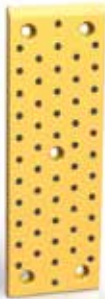

CODE	X	Y	Z
S111311.030010012	300	100	12

## S1.1 PIASTRA GUIDA BRONZO AUTOLUBRIFICANTE

S1.1 WEAR PLATE SELF-LUBRICATING

S1.1 GLEITPLATTE BRONZE MIT FESTSCHMIERSTOFF

### S1.113.30

VDI

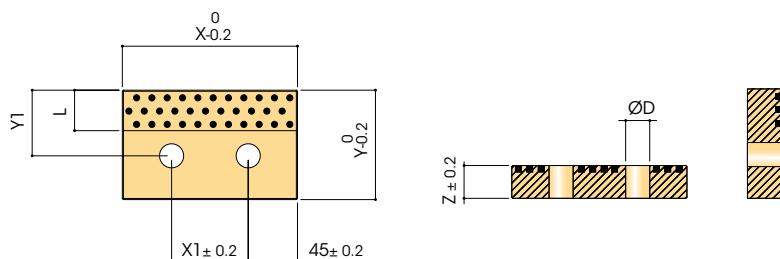

CODE	X	Y	Z	X1	Y1	L	D
S111330.016003510	160	35	10	70	20	10	11
S111330.020003510	200	35	10	110	20	10	11
S111330.016004515	160	45	15	70	30	15	13,5
S111330.020004515	200	45	15	110	30	15	13,5
S111330.016005515	160	55	15	70	35	20	17,5
S111330.020005515	200	55	15	110	35	20	17,5
S111330.016007525	160	75	25	70	40	25	17,5
S111330.020007525	200	75	25	110	40	25	17,5
S111330.016010025	160	100	25	70	60	30	17,5
S111330.020010025	200	100	25	110	60	30	17,5
S111330.016012525	160	125	25	70	75	30	17,5
S111330.020012525	200	125	25	110	75	30	17,5
S111330.016008530	160	85	30	70	60	30	22
S111330.020008530	200	85	30	110	60	30	22
S111330.016010030	160	100	30	70	60	30	22
S111330.020010030	200	100	30	110	60	30	22
S111330.016012530	160	125	30	70	75	30	22
S111330.020012530	200	125	30	110	75	30	22

## S1.1 PIASTRA GUIDA BRONZO AUTOLUBRIFICANTE

S1.1 WEAR PLATE SELF-LUBRICATING

S1.1 GLEITPLATTE BRONZE MIT FESTSCHMIERSTOFF

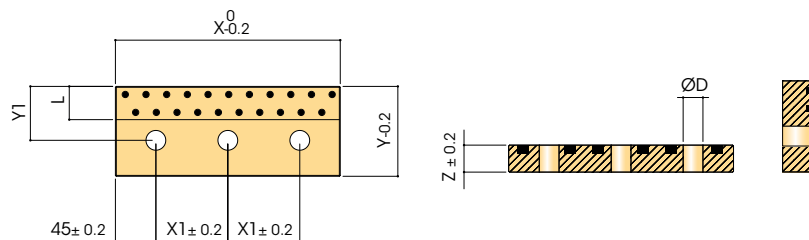

CODE	X	Y	Z	X1	Y1	L	D
S111330.025003510	250	35	10	80	20	10	11
S111330.025004515	250	45	15	80	30	15	13,5
S111330.025005515	250	55	15	80	35	20	17,5
S111330.025007525	250	75	25	80	40	25	17,5
S111330.025010025	250	100	25	80	60	30	17,5
S111330.025012525	250	125	25	80	75	30	17,5
S111330.024008528	240	85	28	95	60	30	22
S111330.025008530	250	85	30	80	60	30	22
S111330.030008530	300	85	30	105	60	30	22
S111330.035008530	350	85	30	130	60	30	22
S111330.025010030	250	100	30	80	60	30	22
S111330.025012530	250	125	30	80	75	30	22
S111330.030012530	300	125	30	105	75	30	22
S111330.035012530	350	125	30	130	75	30	22

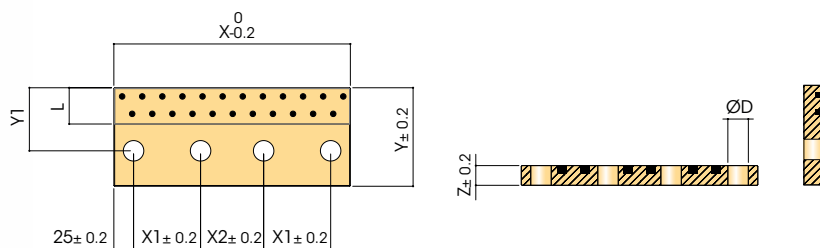

CODE	X	Y	Z	X1	X2	L	D
S111330.030012525	300	125	25	85	80	80	26
S111330.035012525	350	125	25	100	100	80	26
S111330.B40012525	400	125	25	115	120	80	26
S111330.030008528	300	85	28	85	80	60	22
S111330.035008528	350	85	28	100	100	60	22
S111330.040008528	400	85	28	115	120	60	22



## S1.1 PIASTRA GUIDA BRONZO AUTOLUBRIFICANTE

S1.1 WEAR PLATE SELF-LUBRICATING

S1.1 GLEITPLATTE BRONZE MIT FESTSCHMIERSTOFF

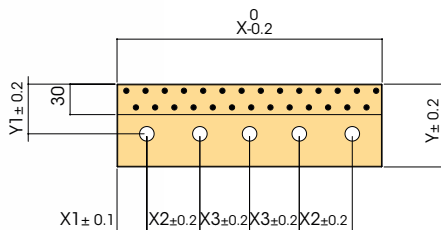

CODE	X	Y	Z	X1	X2	X3	Y1	D
S111330.040010025	400	100	25	45	80	75	60	17,5
S111330.040012525	400	125	25	45	80	75	75	17,5
S111330.045012525	450	125	25	25	100	100	80	26
S111330.050012525	500	125	25	25	110	115	80	26
S111330.045008528	450	85	28	25	100	100	60	22
S111330.040008530	400	85	30	45	80	75	60	22
S111330.040010030	400	100	30	45	80	75	60	22
S111330.040012530	400	125	30	45	80	75	75	22
S111330.045012530	450	125	30	50	80	95	75	22
S111330.050012530	500	125	30	50	80	120	75	22

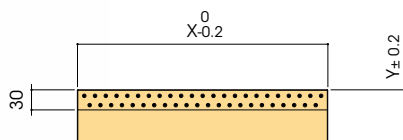

CODE	X	Y	Z
S111330.100508530	1005	85	30
S111330.100512525	1005	125	25
S111330.100512530	1005	125	30

## S1.1 PIASTRA GUIDA BRONZO AUTOLUBRIFICANTE

S1.1 WEAR PLATE SELF-LUBRICATING

S1.1 GLEITPLATTE BRONZE MIT FESTSCHMIERSTOFF

### S1.114.10

NAMMS

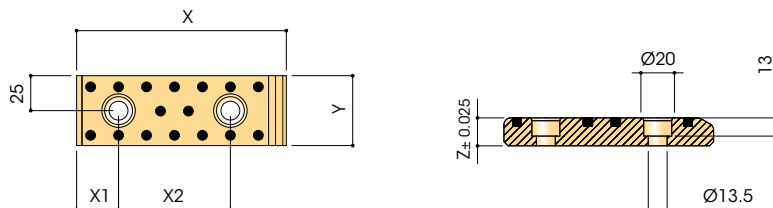

CODE	X	Y	Z	X1	X2
S111410.010005020	100	50	20	30	30
S111410.015005020	150	50	20	30	80
S111410.020005020	200	50	20	40	120

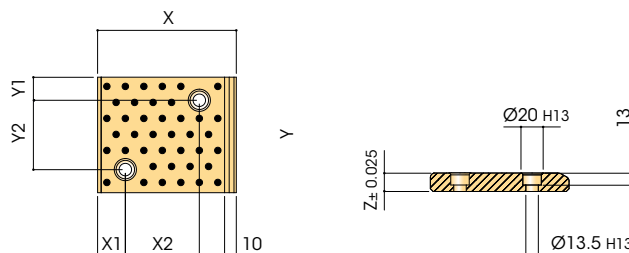

CODE	X	Y	Z	X1	X2	Y1	Y2
S111410.010008020	100	80	20	30	30	20	40
S111410.015008020	150	80	20	30	80	20	40
S111410.020008020	200	80	20	40	120	20	40
S111410.025008020	250	80	20	40	170	20	40
S111410.010010020	100	100	20	30	30	22	56
S111410.015010020	150	100	20	30	80	22	56
S111410.010012520	100	125	20	30	30	25	75
S111410.015012520	150	125	20	30	80	25	75
S111410.010016020	100	160	20	30	30	30	100
S111410.015016020	150	160	20	30	80	30	100

## S1.1 PIASTRA GUIDA BRONZO AUTOLUBRIFICANTE

S1.1 WEAR PLATE SELF-LUBRICATING

S1.1 GLEITPLATTE BRONZE MIT FESTSCHMIERSTOFF

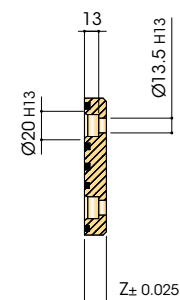
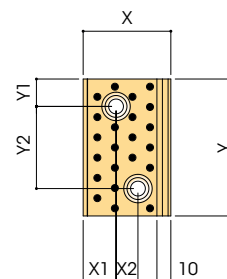

CODE	X	Y	Z	X1	X2	Y1	Y2
S111410.005010020	50	100	20	14	13	22	56
S111410.008010020	80	100	20	30	20	22	56
S111410.008012520	80	125	20	30	20	25	75

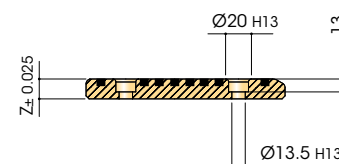
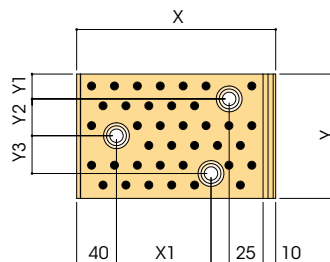

CODE	X	Y	Z	X1	Y1	Y2	Y3
S111410.031508020	315	80	20	210	20	20	20
S111410.020010020	200	100	20	95	22	28	28
S111410.025010020	250	100	20	145	22	28	28
S111410.031510020	315	100	20	210	22	28	28
S111410.020012520	200	125	20	95	25	37	38
S111410.025012520	250	125	20	145	25	37	38
S111410.020016020	200	160	20	95	30	50	50

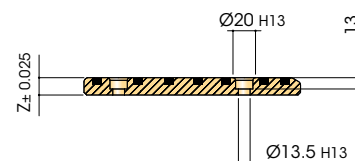
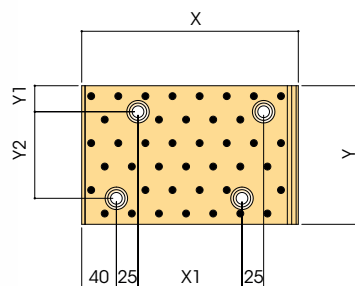

CODE	X	Y	Z	X1	Y1	Y2
S111410.031512520	315	125	20	185	25	75
S111410.025016020	250	160	20	120	30	100
S111410.031516020	315	160	20	185	30	100

**S1.1 PIASTRA GUIDA BRONZO AUTOLUBRIFICANTE**

**S1.1 WEAR PLATE SELF-LUBRICATING**

**S1.1 GLEITPLATTE BRONZE MIT FESTSCHMIERSTOFF**

**S1.115.10**

AFNOR/CNOMO

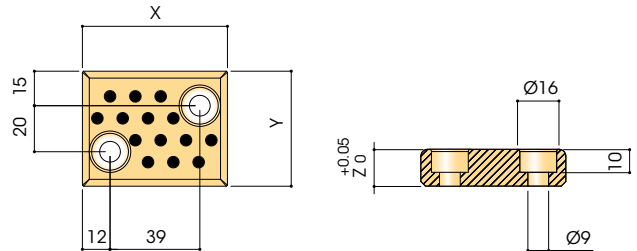

CODE	X	Y	Z
S111510.006305016	63	50	16

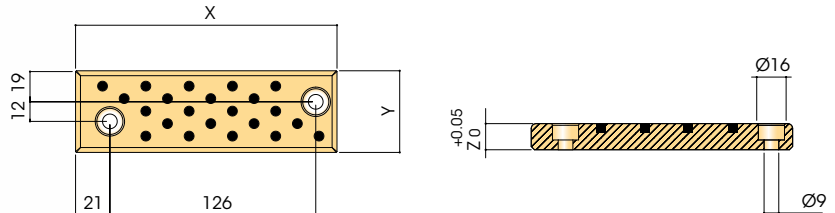

CODE	X	Y	Z
S111510.016005016	160	50	16

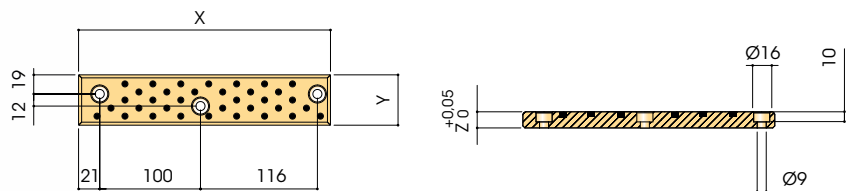

CODE	X	Y	Z
S111510.025005016	250	50	16

## S1.1 PIASTRA GUIDA BRONZO AUTOLUBRIFICANTE

S1.1 WEAR PLATE SELF-LUBRICATING

S1.1 GLEITPLATTE BRONZE MIT FESTSCHMIERSTOFF

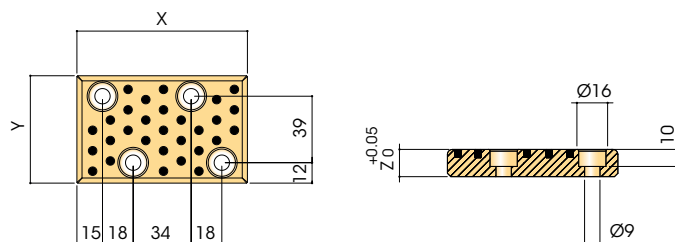

CODE	X	Y	Z
S111510.010006316	100	63	16

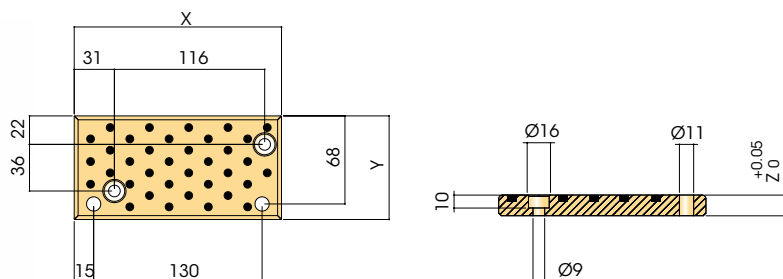
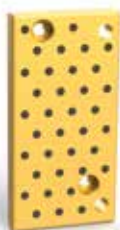

CODE	X	Y	Z
S111510.016008016	160	80	16

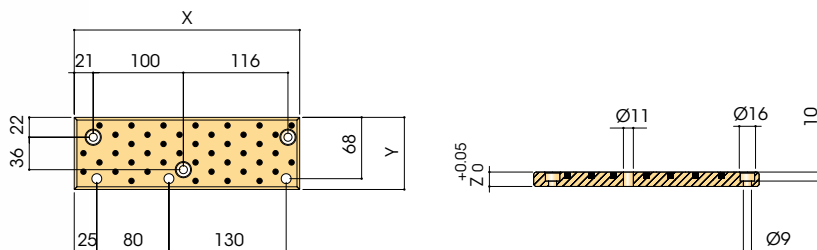

CODE	X	Y	Z
S111510.025008016	250	80	16

**S1.1 PIASTRA GUIDA BRONZO AUTOLUBRIFICANTE**

S1.1 WEAR PLATE SELF-LUBRICATING

S1.1 GLEITPLATTE BRONZE MIT FESTSCHMIERSTOFF

**S1.115.30**

AFNOR/CNOMO

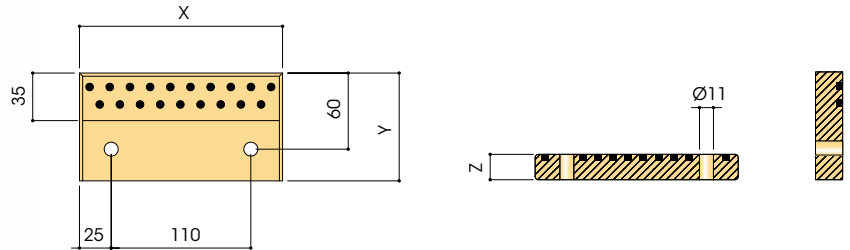

CODE	X	Y	Z
S111530.016008520	160	85	20

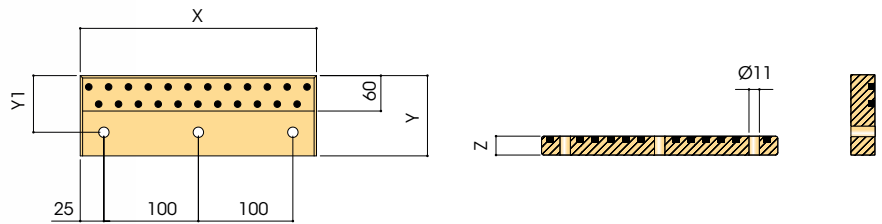

CODE	X	Y	Z
S111530.025008520	250	85	20

## S1.1 PIASTRA GUIDA BRONZO AUTOLUBRIFICANTE

S1.1 WEAR PLATE SELF-LUBRICATING

S1.1 Gleitplatte Bronze mit Festschmierstoff

### S1.116.10

FCA

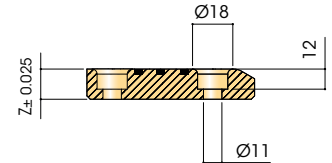
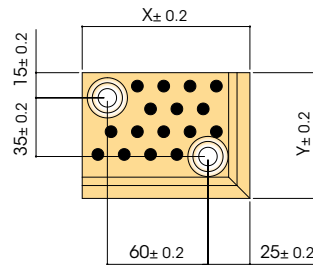

CODE	X	Y	Z
S111610.010007518	100	75	18

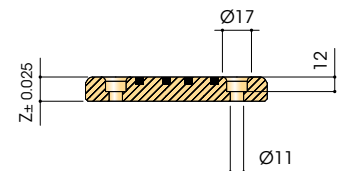
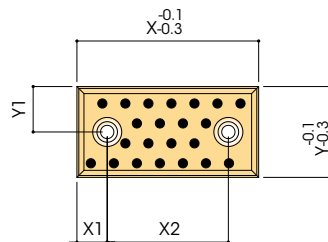

CODE	X	Y	Z	X1	X2	Y1
S111610.007503820	75	38	20	15	45	19
S111610.010003820	100	38	20	25	50	19
S111610.015003820	150	38	20	25	100	19
S111610.020003820	200	38	20	25	150	19
S111610.007507520	75	75	20	15	45	37,5
S111610.015007520	150	75	20	25	100	37,5
S111610.020007520	200	75	20	25	150	37,5

## S1.1 PIASTRA GUIDA BRONZO AUTOLUBRIFICANTE

S1.1 WEAR PLATE SELF-LUBRICATING

S1.1 GLEITPLATTE BRONZE MIT FESTSCHMIERSTOFF

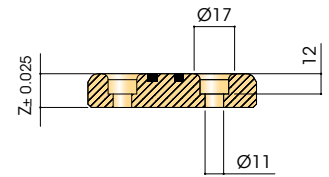
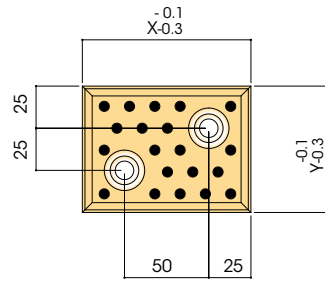

CODE	X	Y	Z
S111610.010007520	100	75	20

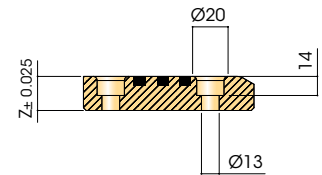
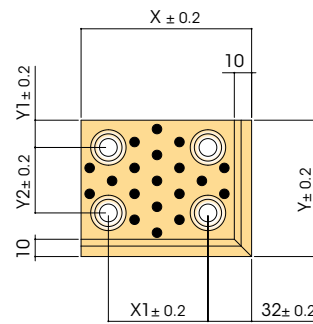

CODE	X	Y	Z	X1	Y1	Y2
S111610.012510025	125	100	25	73	20	48
S111610.015012525	150	125	25	93	25	68

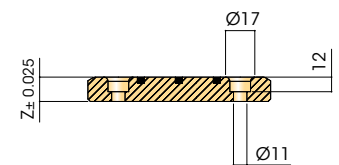
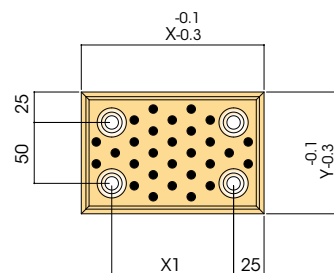

CODE	X	Y	Z	X1
S111610.010010020	100	100	20	50
S111610.015010020	150	100	20	100
S111610.020010020	200	100	20	150

CODE	X	Y	Z	X1
S111610.025010020	250	100	20	200
S111610.030010020	300	100	20	250



## S1.1 PIASTRA GUIDA BRONZO AUTOLUBRIFICANTE

S1.1 WEAR PLATE SELF-LUBRICATING

S1.1 GLEITPLATTE BRONZE MIT FESTSCHMIERSTOFF

### S1.120.00

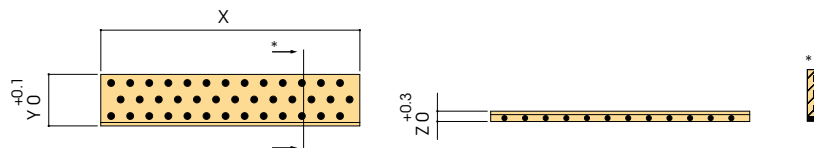

CODE	X	Y	Z
S112000.030502505	305	25	5
S112000.030503006	305	30	6
S112000.060504008	605	40	8
S112000.100504008	1005	40	8
S112000.060503510	605	35	10
S112000.100503510	1005	35	10
S112000.060505010	605	50	10
S112000.100505010	1005	50	10
S112000.060504012	605	40	12
S112000.100504012	1005	40	12

CODE	X	Y	Z
S112000.060508012	605	80	12
S112000.100508012	1005	80	12
S112000.060506016	605	60	16
S112000.100506016	1005	60	16
S112000.100505020	1005	50	20
S112000.100506020	1005	60	20
S112000.060508020	605	80	20
S112000.100508020	1005	80	20
S112000.060510020	605	100	20
S112000.100510020	1005	100	20

## S1.1 PIASTRA GUIDA BRONZO AUTOLUBRIFICANTE

S1.1 WEAR PLATE SELF-LUBRICATING

S1.1 GLEITPLATTE BRONZE MIT FESTSCHMIERSTOFF

### S1.120.01

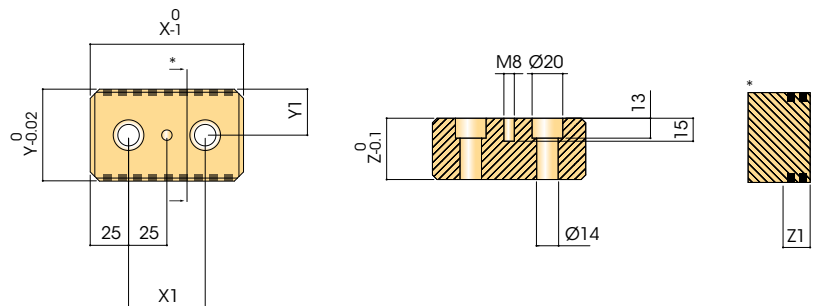

CODE	X	Y	Z	X1	Y1	Z1
S112001.010003030	100	30	30	50	15	18
S112001.015003030	150	30	30	100	15	18
S112001.010004030	100	40	30	50	20	18
S112001.015004030	150	40	30	100	20	18
S112001.010004040	100	40	40	50	20	18
S112001.015004040	150	40	40	100	20	18
S112001.010006040	100	60	40	50	30	25

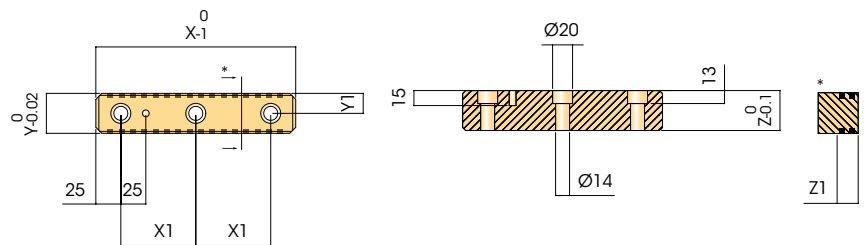

CODE	X	Y	Z	X1	Y1	Z1
S112001.020003030	200	30	30	75	15	18
S112001.025003030	250	30	30	100	15	18
S112001.030003030	300	30	30	125	15	18
S112001.035003030	350	30	30	150	15	18
S112001.020004030	200	40	30	75	20	18
S112001.025004030	250	40	30	100	20	18
S112001.030004030	300	40	30	125	20	18
S112001.035004030	350	40	30	150	20	18
S112001.020004040	200	40	40	75	20	20
S112001.025004040	250	40	40	100	20	20
S112001.030004040	300	40	40	125	20	20
S112001.035004040	350	40	40	150	20	20
S112001.025006040	250	60	40	100	30	25
S112001.030006040	300	60	40	125	30	25
S112001.035006040	350	60	40	150	30	25

## S1.1 PIASTRA GUIDA BRONZO AUTOLUBRIFICANTE

S1.1 WEAR PLATE SELF-LUBRICATING

S1.1 GLEITPLATTE BRONZE MIT FESTSCHMIERSTOFF

### S1.120.10

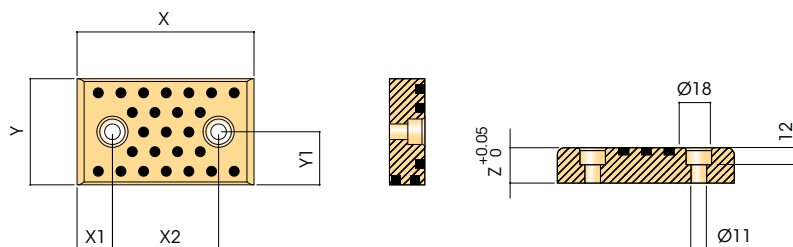

CODE	X	Y	Z	X1	X2	Y1
S112010.007502825	75	28	25	15	45	14
S112010.010002825	100	28	25	25	50	14
S112010.015002825	150	28	25	25	100	14
S112010.007503825	75	38	25	15	45	19
S112010.010003825	100	38	25	25	50	19
S112010.012503825	125	38	25	25	75	19
S112010.015003825	150	38	25	25	100	19
S112010.007504825	75	48	25	15	45	24
S112010.010004825	100	48	25	25	50	24
S112010.012504825	125	48	25	25	75	24
S112010.015004825	150	48	25	25	100	24
S112010.020004825	200	48	25	25	150	24
S112010.007505825	75	58	25	15	45	29
S112010.010005825	100	58	25	25	50	29
S112010.012505825	125	58	25	25	75	29
S112010.015005825	150	58	25	25	100	29
S112010.020005825	200	58	25	25	150	29
S112010.007507525	75	75	25	15	45	37,5
S112010.010007525	100	75	25	25	50	37,5
S112010.012507525	125	75	25	25	75	37,5
S112010.015007525	150	75	25	25	100	37,5
S112010.020007525	200	75	25	25	150	37,5

## S1.1 PIASTRA GUIDA BRONZO AUTOLUBRIFICANTE

S1.1 WEAR PLATE SELF-LUBRICATING

S1.1 GLEITPLATTE BRONZE MIT FESTSCHMIERSTOFF

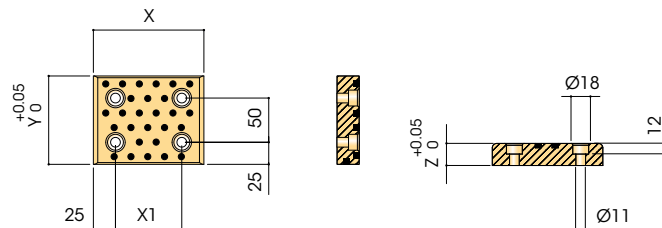

CODE	X	Y	Z	X1
S112010.010010025	100	100	25	50
S112010.012510025	125	100	25	75
S112010.015010025	150	100	25	100

CODE	X	Y	Z	X1
S112010.020010025	200	100	25	150
S112010.025010025	250	100	25	200

## S1.120.30

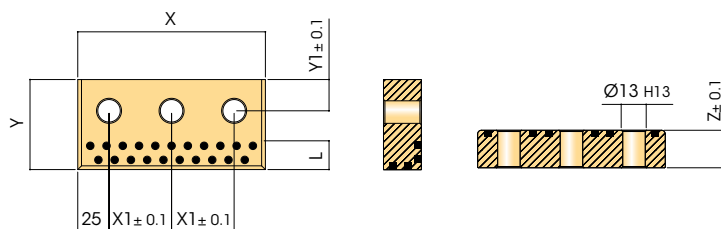

CODE	X	Y	Z	X1	Y1	L
S112030.015005220	150	52	20	50	20	12
S112030.020005220	200	52	20	75	20	12
S112030.015007230	150	72	30	50	25	22
S112030.020007230	200	72	30	75	25	22
S112030.015007735	150	77	35	50	25	27
S112030.020007735	200	77	35	75	25	27
S112030.015008240	150	82	40	50	25	32
S112030.020008240	200	82	40	75	25	32

## S1.1 PIASTRA GUIDA BRONZO AUTOLUBRIFICANTE

S1.1 WEAR PLATE SELF-LUBRICATING

S1.1 GLEITPLATTE BRONZE MIT FESTSCHMIERSTOFF

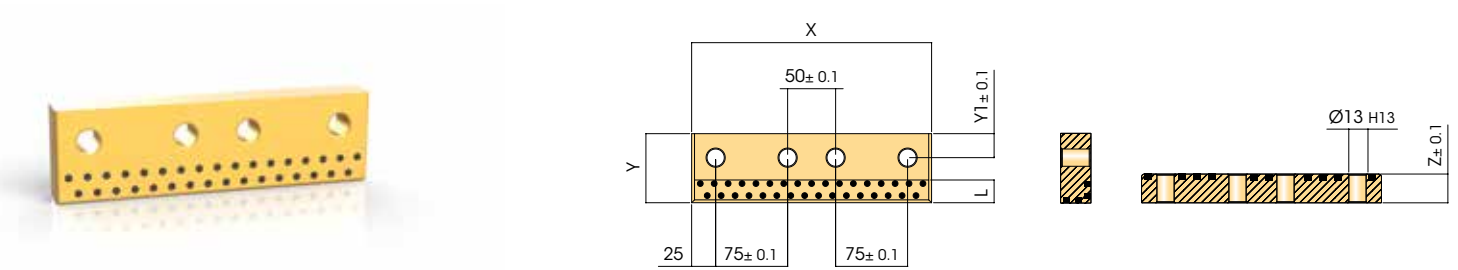

CODE	X	Y	Z	Y1	L	D
S112030.025005220	250	52	20	20	12	13
S112030.025007230	250	72	30	25	22	18
S112030.025007735	250	77	35	25	27	18
S112030.025008240	250	82	40	25	32	18

## S1.120.31

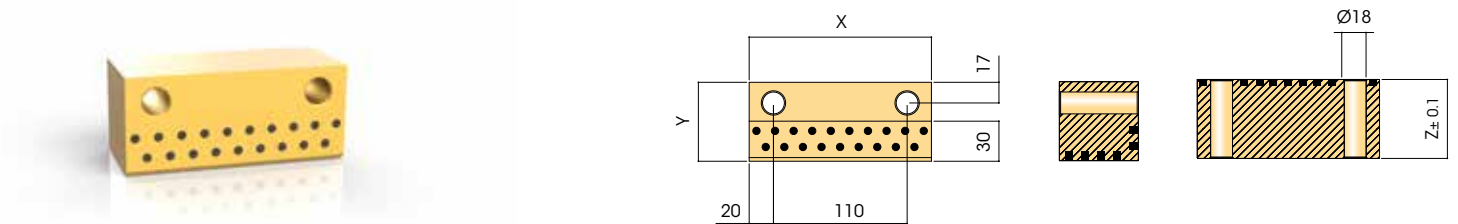

CODE	X	Y	Z
S112031.015006540	150	65	40
S112031.015006565	150	65	65

## S1.1 PIASTRA GUIDA BRONZO AUTOLUBRIFICANTE

S1.1 WEAR PLATE SELF-LUBRICATING

S1.1 GLEITPLATTE BRONZE MIT FESTSCHMIERSTOFF

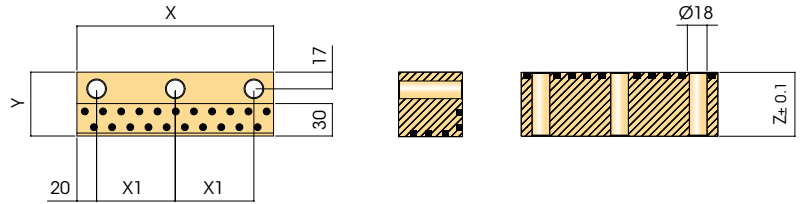

CODE	X	Y	Z	X1
S112031.020006540	200	65	40	80
S112031.025006540	250	65	40	105

CODE	X	Y	Z	X1
S112031.020006565	200	65	65	80
S112031.025006565	250	65	65	105

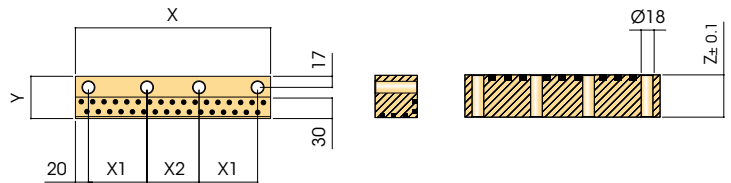

CODE	X	Y	Z	X1	X2
S112031.030006540	300	65	40	90	80
S112031.035006540	350	65	40	105	100

CODE	X	Y	Z	X1	X2
S112031.030006565	300	65	65	90	80
S112031.035006565	350	65	65	105	100

## S1.1 PIASTRA GUIDA BRONZO AUTOLUBRIFICANTE

S1.1 WEAR PLATE SELF-LUBRICATING

S1.1 GLEITPLATTE BRONZE MIT FESTSCHMIERSTOFF

### S1.123.10

VDI

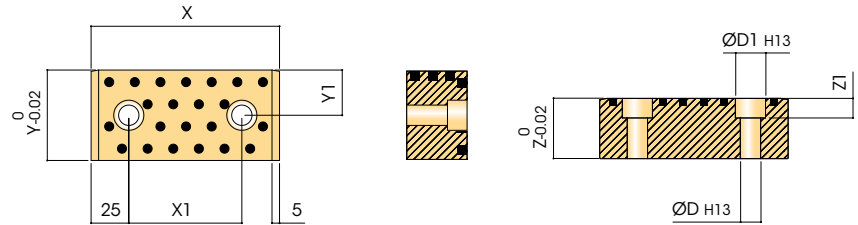

CODE	X	Y	Z	X1	Y1	D	D1	Z1
S112310.011002512	110	25	12	60	12,5	9	15	8,5
S112310.012002512	120	25	12	70	12,5	9	15	8,5
S112310.011002515	110	25	15	60	12,5	11	18	10,5
S112310.012002515	120	25	15	70	12,5	11	18	10,5
S112310.012506030	125	60	30	75	30	13,5	20	13
S112310.015006030	150	60	30	100	30	13,5	20	13
S112310.016006030	160	60	30	110	30	13,5	20	13
S112310.012506040	125	60	40	75	30	13,5	20	13
S112310.015006040	150	60	40	100	30	13,5	20	13
S112310.016006040	160	60	40	110	30	13,5	20	13

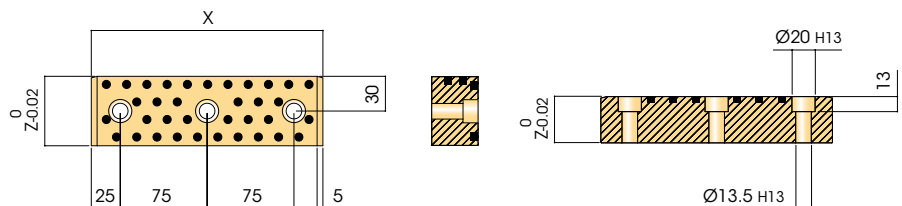

CODE	X	Y	Z
S112310.020006030	200	60	30
S112310.020006040	200	60	40

## S1.1 PIASTRA GUIDA BRONZO AUTOLUBRIFICANTE

S1.1 WEAR PLATE SELF-LUBRICATING

S1.1 GLEITPLATTE BRONZE MIT FESTSCHMIERSTOFF

### S1.125.10

AFNOR/CNOMO

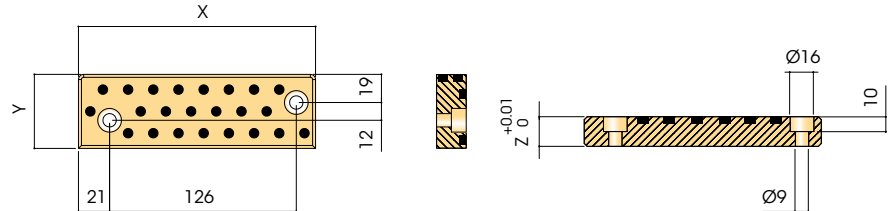

CODE	X	Y	Z
S112510.016005020	160	50	20

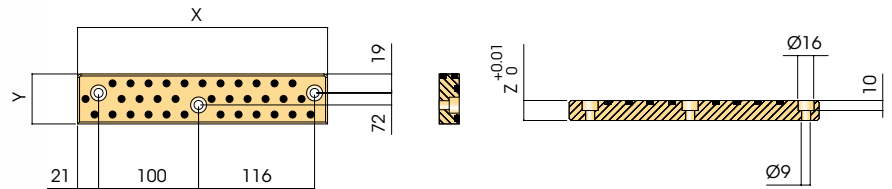

CODE	X	Y	Z
S112510.025005020	250	50	20

### S1.126.10

FCA

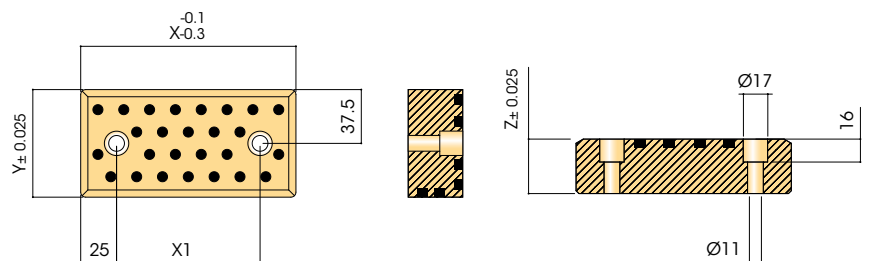

CODE	X	Y	Z	X1
S112610.010010020	100	100	20	50
S112610.012510020	125	100	20	75
S112610.015010020	150	100	20	100

CODE	X	Y	Z	X1
S112610.020010020	200	100	20	150
S112610.025010020	250	100	20	200



## S1.1 PIASTRA GUIDA BRONZO AUTOLUBRIFICANTE

S1.1 WEAR PLATE SELF-LUBRICATING

S1.1 Gleitplatte Bronze mit Festschmierstoff

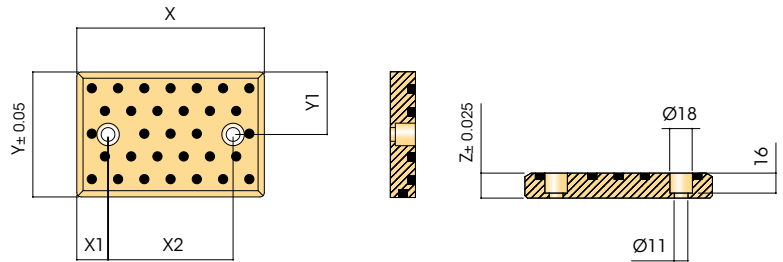

CODE	X	Y	Z	X1	X2	Y1
S112610.007502820	75	28	20	15	45	14
S112610.010002820	100	28	20	25	50	14
S112610.015002820	150	28	20	25	100	14
S112610.007503820	75	38	20	15	45	19
S112610.010003820	100	38	20	25	50	19
S112610.012503820	125	38	20	25	75	19
S112610.015003820	150	38	20	25	100	19
S112610.007504820	75	48	20	15	45	24
S112610.010004820	100	48	20	25	50	24
S112610.012504820	125	48	20	25	75	24
S112610.015004820	150	48	20	25	100	24
S112610.020004820	200	48	20	25	150	24
S112610.007505820	75	58	20	15	45	29
S112610.010005820	100	58	20	25	50	29
S112610.012505820	125	58	20	25	75	29
S112610.015005820	150	58	20	25	100	29
S112610.020005820	200	58	20	25	150	29
S112610.007507520	75	75	20	15	45	37,5
S112610.010007520	100	75	20	25	50	37,5
S112610.012507520	125	75	20	25	75	37,5
S112610.015007520	150	75	20	25	100	37,5
S112610.020007520	200	75	20	25	150	37,5

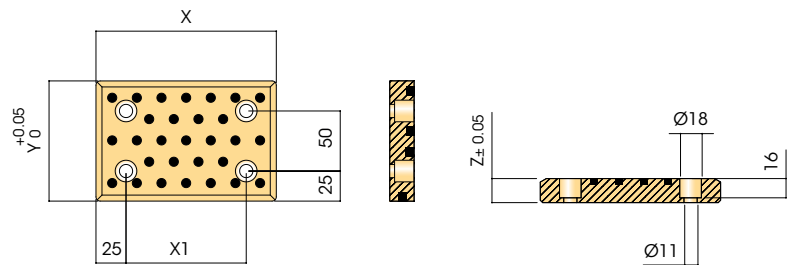

CODE	X	Y	Z	X1
S112610.010007538	100	75	38	50
S112610.015007538	150	75	38	100

**S1.1 PIASTRA GUIDA BRONZO AUTOLUBRIFICANTE**

**S1.1 WEAR PLATE SELF-LUBRICATING**

**S1.1 GLEITPLATTE BRONZE MIT FESTSCHMIERSTOFF**

**S1.128.10**

OPEL

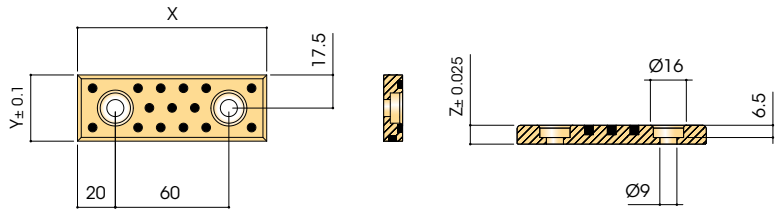

CODE	X	Y	Z
S112810.010003510	100	35	10

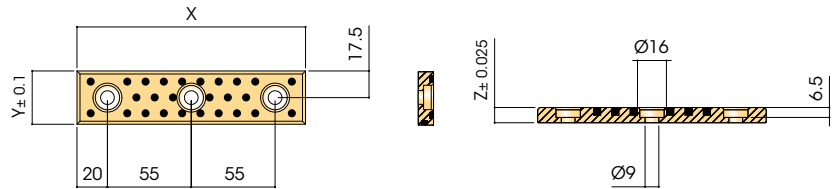

CODE	X	Y	Z
S112810.015003510	150	35	10

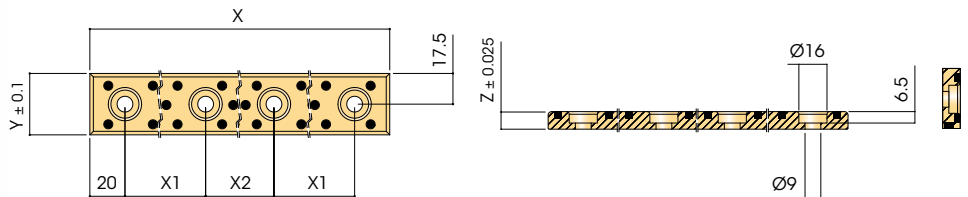

CODE	X	Y	Z	X1	X2
S112810.020003510	200	35	10	55	50
S112810.025003510	250	35	10	70	70

## S1.1 PIASTRA GUIDA BRONZO AUTOLUBRIFICANTE

S1.1 WEAR PLATE SELF-LUBRICATING

S1.1 GLEITPLATTE BRONZE MIT FESTSCHMIERSTOFF

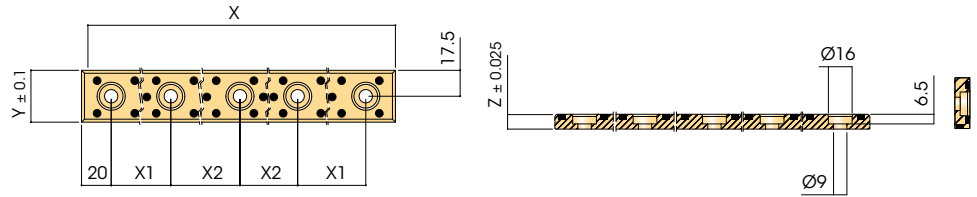

CODE	X	Y	Z	X1	X2
S112810.030003510	300	35	10	65	65
S112810.035003510	350	35	10	80	75

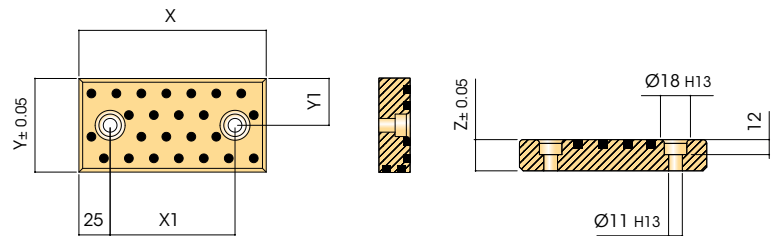

CODE	X	Y	Z	X1	Y1
S112810.015005025	150	50	25	100	25
S112810.020005025	200	50	25	150	25
S112810.015007525	150	75	25	100	37,5

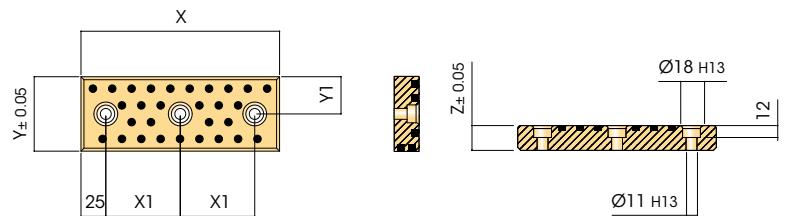

CODE	X	Y	Z	X1	Y1
S112810.025005025	250	50	25	100	25
S112810.020007525	200	75	25	75	37,5
S112810.025007525	250	75	25	100	37,5

## S1.1 PIASTRA GUIDA BRONZO AUTOLUBRIFICANTE

S1.1 WEAR PLATE SELF-LUBRICATING

S1.1 GLEITPLATTE BRONZE MIT FESTSCHMIERSTOFF

### S1.130.00

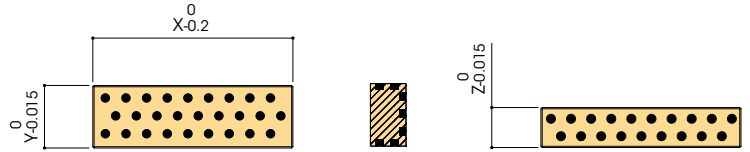

CODE	X	Y	Z
S113000.008002516	80	25	16
S113000.010002516	100	25	16
S113000.012502516	125	25	16
S113000.012504025	125	40	25
S113000.016004025	160	40	25

CODE	X	Y	Z
S113000.020004025	200	40	25
S113000.020006340	200	63	40
S113000.025006340	250	63	40
S113000.031506340	315	63	40

## S1.1 PIASTRA GUIDA BRONZO AUTOLUBRIFICANTE

S1.1 WEAR PLATE SELF-LUBRICATING

S1.1 GLEITPLATTE BRONZE MIT FESTSCHMIERSTOFF

### S1.130.30

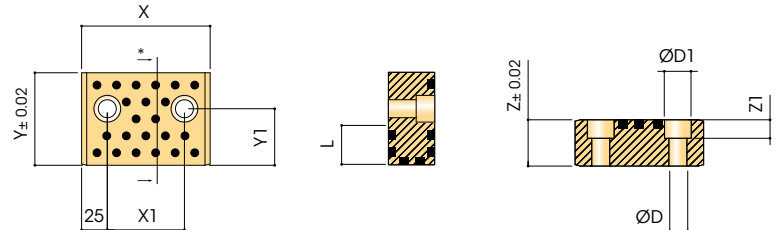

CODE	X	Y	Z	X1	Y1	L	D	D1	Z1
S113030.012507032	125	70	32	75	40	25	13,5	20	14
S113030.015007032	150	70	32	100	40	25	13,5	20	14
S113030.012509045	125	90	45	75	55	30	18	26	17,5

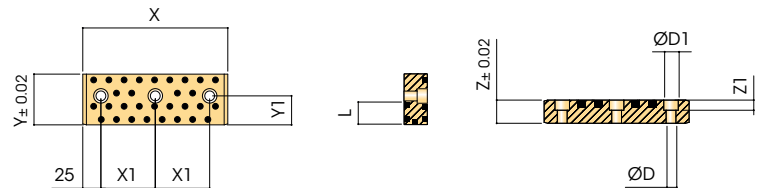

CODE	X	Y	Z	X1	Y1	L	D	D1	Z1
S113030.020007032	200	70	32	75	40	25	13,5	20	14
S113030.015009045	150	90	45	50	55	30	18	26	17,5
S113030.020009045	200	90	45	75	55	30	18	26	17,5

## S1.1 PIASTRA GUIDA BRONZO AUTOLUBRIFICANTE

S1.1 WEAR PLATE SELF-LUBRICATING

S1.1 GLEITPLATTE BRONZE MIT FESTSCHMIERSTOFF

### S1.140.00

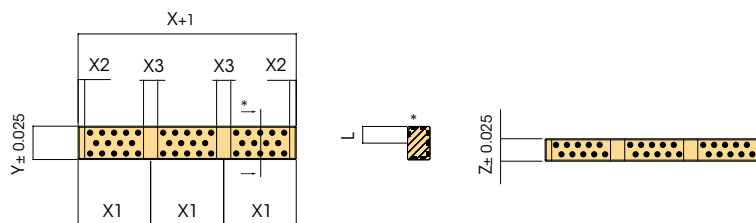

CODE	X	Y	Z	X1	X2	X3	L
S114000.007501510	75	15,3	10,3	25	3	6	6
S114000.010001510	100	15,3	10,3	25	3	6	6
S114000.012501510	125	15,3	10,3	25	3	6	6
S114000.015001510	150	15,3	10,3	25	3	6	6
S114000.017501510	175	15,3	10,3	25	3	6	6
S114000.020001510	200	15,3	10,3	25	3	6	6
S114000.022501510	225	15,3	10,3	25	3	6	6
S114000.025001510	250	15,3	10,3	25	3	6	6
S114000.027501510	275	15,3	10,3	25	3	6	6
S114000.030001510	300	15,3	10,3	25	3	6	6
S114000.010502515	105	25,3	15,3	35	4	8	8
S114000.014002515	140	25,3	15,3	35	4	8	8
S114000.017502515	175	25,3	15,3	35	4	8	8
S114000.021002515	210	25,3	15,3	35	4	8	8
S114000.024502515	245	25,3	15,3	35	4	8	8
S114000.028002515	280	25,3	15,3	35	4	8	8
S114000.031502515	315	25,3	15,3	35	4	8	8
S114000.035002515	350	25,3	15,3	35	4	8	8
S114000.038502515	385	25,3	15,3	35	4	8	8
S114000.042002515	420	25,3	15,3	35	4	8	8
S114000.045502515	455	25,3	15,3	35	4	8	8
S114000.049002515	490	25,3	15,3	35	4	8	8
S114000.013503525	135	35,3	25,3	45	5	10	12
S114000.018003525	180	35,3	25,3	45	5	10	12
S114000.022503525	225	35,3	25,3	45	5	10	12
S114000.027003525	270	35,3	25,3	45	5	10	12
S114000.031503525	315	35,3	25,3	45	5	10	12
S114000.036003525	360	35,3	25,3	45	5	10	12
S114000.040503525	405	35,3	25,3	45	5	10	12
S114000.045003525	450	35,3	25,3	45	5	10	12

## S1.1 PIASTRA GUIDA BRONZO AUTOLUBRIFICANTE

S1.1 WEAR PLATE SELF-LUBRICATING

S1.1 GLEITPLATTE BRONZE MIT FESTSCHMIERSTOFF

CODE	X	Y	Z	X1	X2	X3	L
S114000.049503525	495	35,3	25,3	45	5	10	12
S114000.016504535	165	45,3	35,3	55	6	12	16
S114000.022004535	220	45,3	35,3	55	6	12	16
S114000.027504535	275	45,3	35,3	55	6	12	16
S114000.033004535	330	45,3	35,3	55	6	12	16
S114000.038504535	385	45,3	35,3	55	6	12	16
S114000.044004535	440	45,3	35,3	55	6	12	16
S114000.049504535	495	45,3	35,3	55	6	12	16

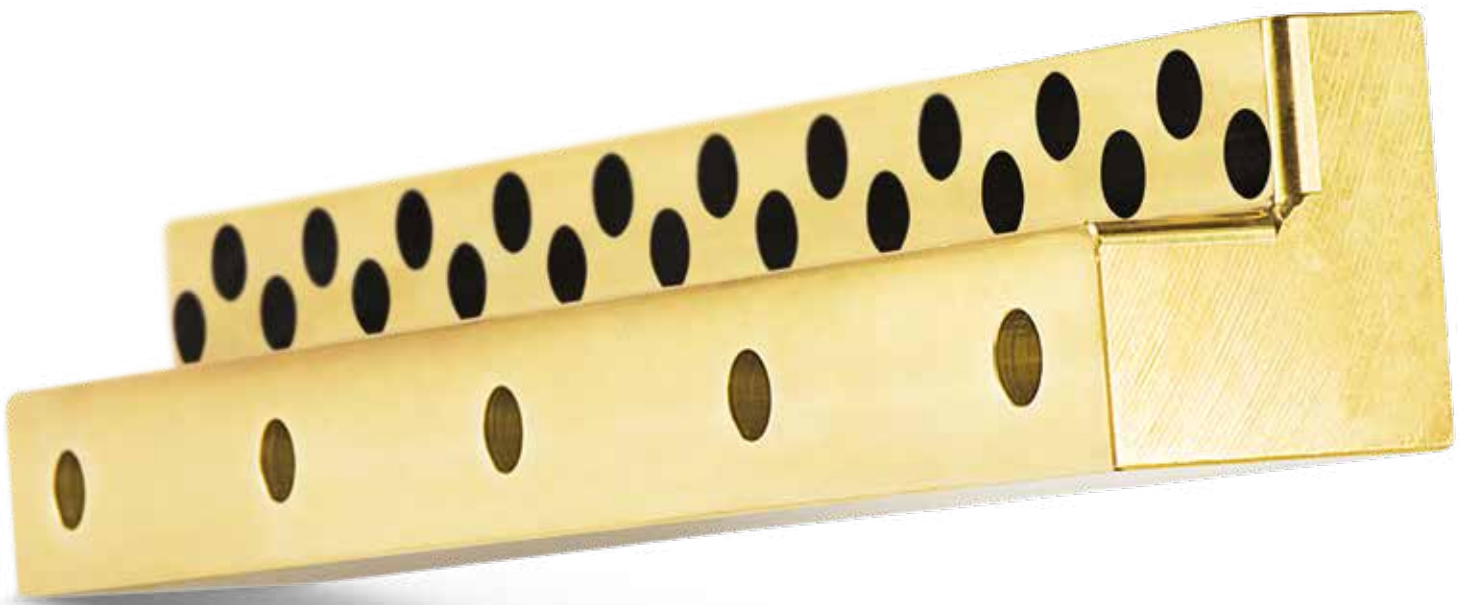



GUIDA  
ANGOLARE  
BRONZO  
AUTOLUBRIFICANTE  
S2

ANGULAR GUIDE SELF-LUBRICATING  
WINKELLEISTE BRONZE MIT FESTCHMIERSTOFF

**MATERIAL** BRONZE with solid lubricant **HARDENESS** >190 HB

## S2 GUIDA ANGOLARE BRONZO AUTOLUBRIFICANTE

S2 ANGULAR GUIDE SELF-LUBRICATING

S2 WINKELLEISTE BRONZE MIT FESTSCHMIERSTOFF

### S2.020.00

AFNOR/CNOMO

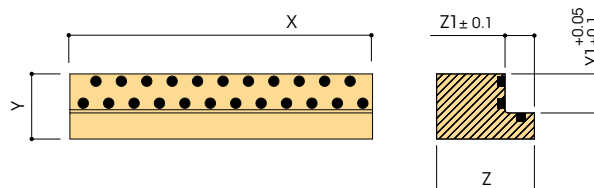

CODE	X	Y	Z	Y1	Z1
S202000.0305012020	305	12	20	6	5
S202000.0605012020	605	12	20	6	5
S202000.0305015025	305	15	25	8	7
S202000.0605015025	605	15	25	8	7
S202000.1005015025	1005	15	25	8	7
S202000.0305020030	305	20	30	12	9
S202000.0605020030	605	20	30	12	9
S202000.1005020030	1005	20	30	12	9

CODE	X	Y	Z	Y1	Z1
S202000.0605030032	605	30	32	15	10
S202000.1005030032	1005	30	32	15	10
S202000.0605035035	605	35	35	24	12
S202000.1005035035	1005	35	35	24	12
S202000.0605045050	605	45	50	25	22
S202000.1005045050	1005	45	50	25	22
S202000.0605050050	605	50	50	34	16
S202000.1005050050	1005	50	50	34	16

### S2.020.10

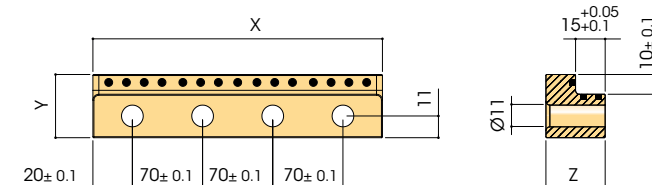

CODE	X	Y	Z
S202010.0250032030	250	32	30

## S2 GUIDA ANGOLARE BRONZO AUTOLUBRIFICANTE

S2 ANGULAR GUIDE SELF-LUBRICATING

S2 WINKELLEISTE BRONZE MIT FESTSCHMIERSTOFF

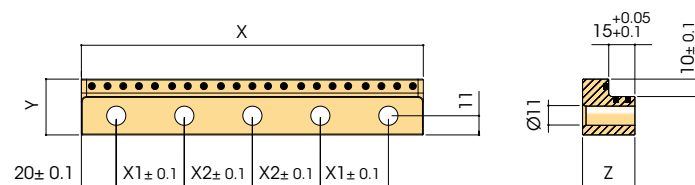

CODE	X	Y	Z	X1	X2
S202010.0300032030	300	32	30	65	65
S202010.0350032030	350	32	30	80	75

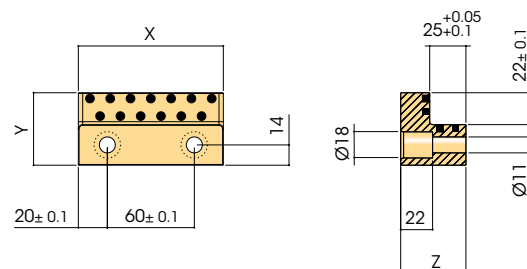

CODE	X	Y	Z
S202010.010005045	100	50	45

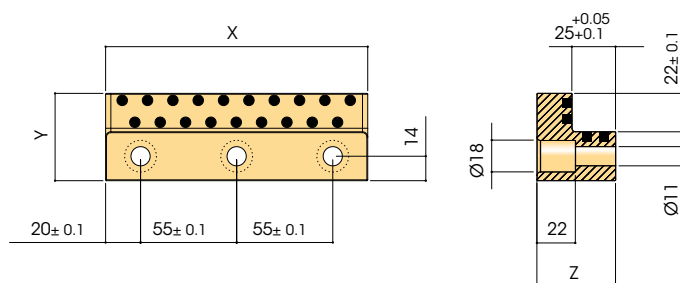

CODE	X	Y	Z
S2.02010.0150050045	150	50	45

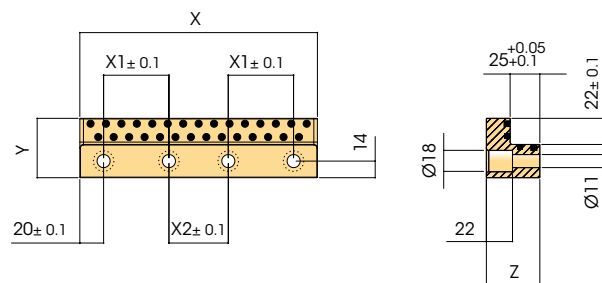

CODE	X	Y	Z	X1	X2
S202010.0200050045	200	50	45	55	50
S202010.0250050045	250	50	45	70	70

## S2 GUIDA ANGOLARE BRONZO AUTOLUBRIFICANTE

S2 ANGULAR GUIDE SELF-LUBRICATING

S2 WINKELLEISTE BRONZE MIT FESTCHMIERSTOFF

### S2.020.11

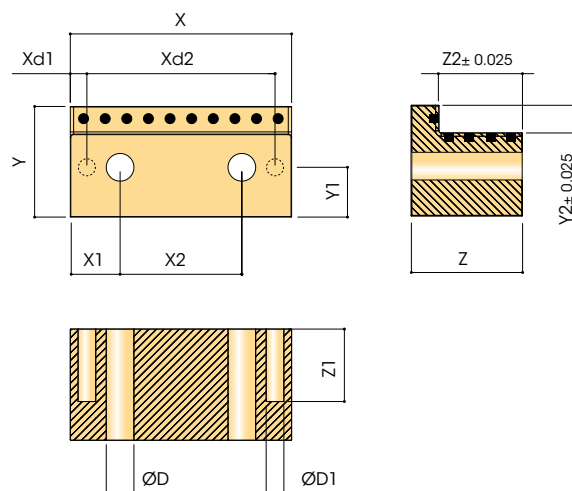

CODE	X	Y	Z	X1	X2	Xd1	Xd2	Y1	Y2	Z1	Z2	D	D1
S202011.0125025015	125	25	15,5	27,5	70	10	105	9	7	10,5	8,5	9	6
S202011.0160025015	160	25	15,5	27,5	105	10	140	9	7	10,5	8,5	9	6
S202011.0125032030	125	32	30,5	27,5	70	10	105	11	10	15,5	15,5	11	8
S202011.0160032030	160	32	30,5	27,5	105	10	140	11	10	15,5	15,5	11	8
S202011.0200032030	200	32	30,5	27,5	145	10	180	11	10	15,5	15,5	11	8
S202011.0100045050	100	45	50,5	27,5	45	10	80	15	15	21,5	34,5	13,5	10
S202011.0125045050	125	45	50,5	27,5	70	10	105	15	15	21,5	34,5	13,5	10
S202011.0160045050	160	45	50,5	27,5	105	10	140	15	15	21,5	34,5	13,5	10
S202011.0100055055	100	55	55,5	27,5	45	10	80	20	18	25,5	39,5	13,5	10
S202011.0160055055	160	55	55,5	27,5	105	10	140	20	18	25,5	39,5	13,5	10
S202011.0160070075	160	70	75,5	35	90	12,5	135	30	20	40,5	55,5	17,5	12
S202011.0200070075	200	70	75,5	35	130	12,5	175	30	20	40,5	55,5	17,5	12
S202011.0160085090	160	85	90,5	42,5	75	15	130	38	22	55,5	65,5	22	16
S202011.0200085090	200	85	90,5	42,5	115	15	170	38	22	55,5	65,5	22	16
S202011.0160100100	160	100	100,5	45	70	15	130	45	25	65,5	75,5	25	16
S202011.0200100100	200	100	100,5	45	110	15	170	45	25	65,5	75,5	25	16

## S2 GUIDA ANGOLARE BRONZO AUTOLUBRIFICANTE

S2 ANGULAR GUIDE SELF-LUBRICATING

S2 WINKELLEISTE BRONZE MIT FESTCHMIERSTOFF

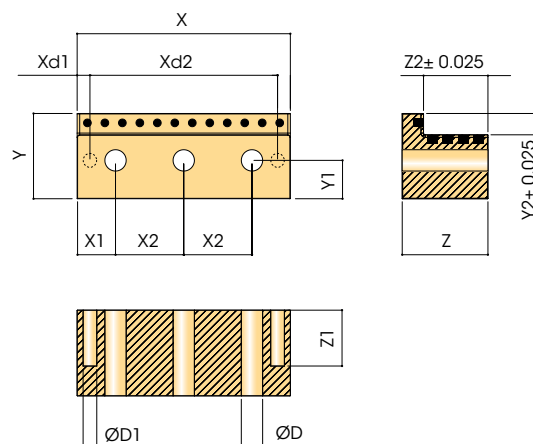

CODE	X	Y	Z	X1	X2	Xd1	Xd2	Y1	Y2	Z1	Z2	D	D1
S202011.0250070075	250	70	75,5	35	90	12,5	225	30	20	40,5	55,5	17,5	12
S202011.0250085090	250	85	90,5	42,5	82,5	15	220	38	22	55,5	65,5	22	16
S202011.0250100100	250	100	100,5	45	80	15	220	45	25	65,5	75,5	25	16

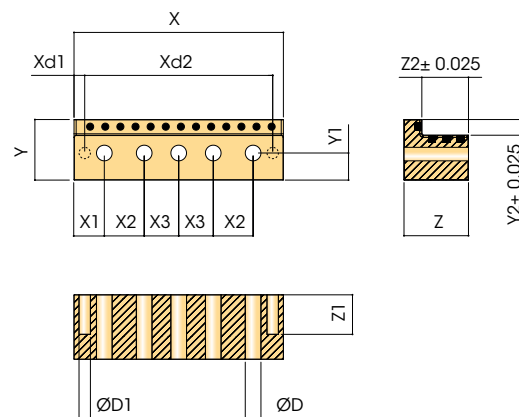

CODE	X	Y	Z	X1	X2	X3	Xd1	Xd2	Y1	Y2	Z1	Z2	D	D1
S202011.0400070075	400	70	75,5	35	90	75	12,5	375	30	20	40,5	55,5	17,5	12
S202011.0400085090	400	85	90,5	42,5	82,5	75	15	370	38	22	55,5	65,5	22	16

## S2 GUIDA ANGOLARE BRONZO AUTOLUBRIFICANTE

S2 ANGULAR GUIDE SELF-LUBRICATING

S2 WINKELLEISTE BRONZE MIT FESTSCHMIERSTOFF

### S2.023.10

VDI

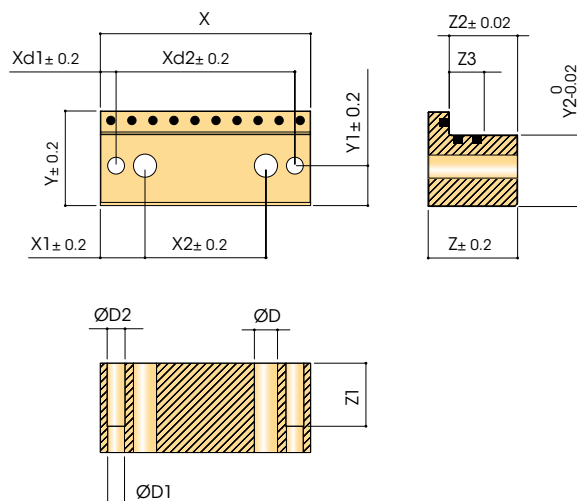

CODE	X	Y	Z	X1	X2	Xd1	Xd2	Y1	Y2	Z1	Z2	Z3	D	D1	D2
S202310.0100055055	100	55	55	27,5	45	10	80	20	37	25	39	23	13,5	10	11
S202310.0160055055	160	55	55	27,5	105	10	140	20	37	25	39	23	13,5	10	11
S202310.0160070075	160	70	75	35	90	12,5	135	30	50	45	55	35	17,5	12	13
S202310.0200070075	200	70	75	35	130	12,5	175	30	50	45	55	35	17,5	12	13
S202310.0160085090	160	85	90	42,5	75	15	130	38	63	60	65	45	22	16	17
S202310.0200085090	200	85	90	42,5	115	15	170	38	63	60	65	45	22	16	17

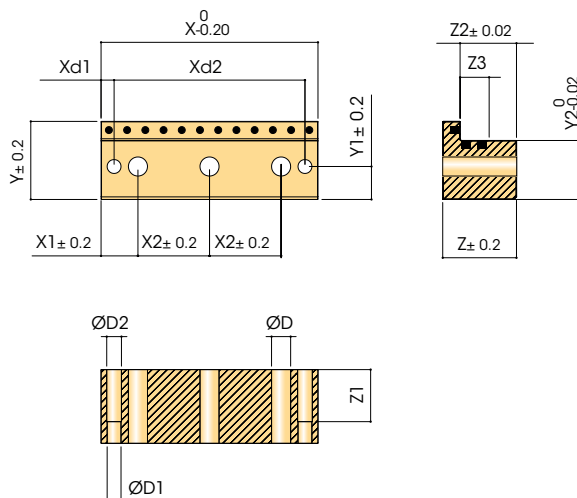

CODE	X	Y	Z	X1	X2	Xd1	Xd2	Y1	Y2	Z1	Z2	Z3	D	D1	D2
S202310.0250070075	250	70	75	35	90	12,5	225	30	50	45	55	35	17,5	12	13
S202310.0250085090	250	85	90	42,5	82,5	15	220	38	63	60	65	45	22	16	17

## S2 GUIDA ANGOLARE BRONZO AUTOLUBRIFICANTE

S2 ANGULAR GUIDE SELF-LUBRICATING

S2 WINKELLEISTE BRONZE MIT FESTCHMIERSTOFF

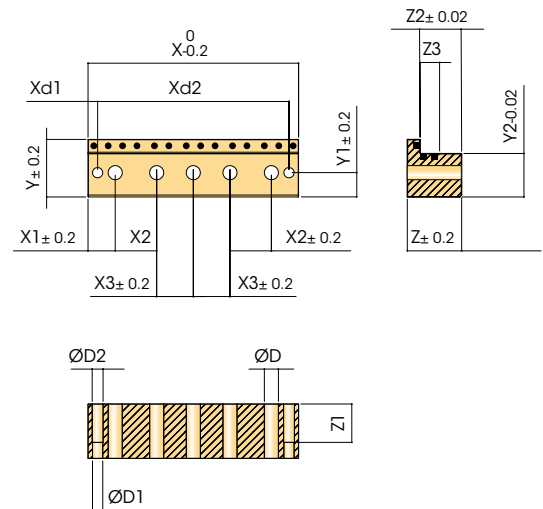

CODE	X	Y	Z	X1	X2	X3	Xd1	Xd2	Y1	Y2	Z1	Z2	Z3	D	D1	D2
S202310.0400070075	400	70	75	35	90	75	12,5	375	30	50	45	55	35	17,5	12	13
S202310.0400085090	400	85	90	42,5	82,5	75	15	370	38	63	60	65	45	22	16	17

## S2 GUIDA ANGOLARE BRONZO AUTOLUBRIFICANTE

S2 ANGULAR GUIDE SELF-LUBRICATING

S2 WINKELLEISTE BRONZE MIT FESTCHMIERSTOFF

### S2.024.30

NAAMS

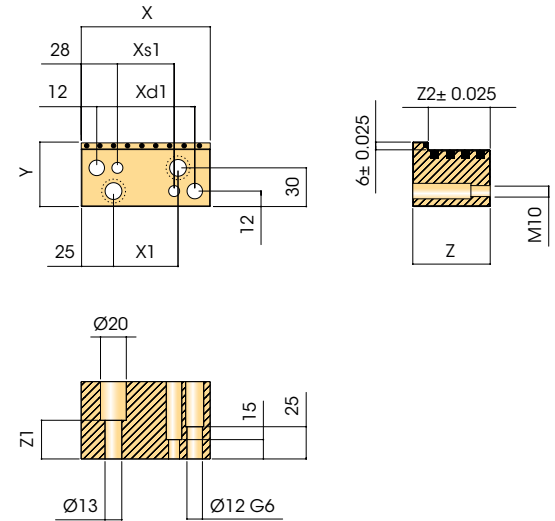
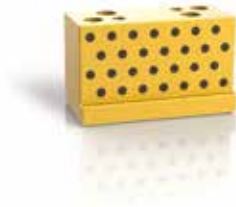

CODE	X	Y	Z	X1	Xd1	Xs1	Z1	Z2
S202430.0075050037	75	50	37	25	51	19	15	25
S202430.0100050037	100	50	37	50	76	44	15	25
S202430.0075050045	75	50	45	25	51	19	15	32
S202430.0100050045	100	50	45	50	76	44	15	32
S202430.0075050050	75	50	50	25	51	19	30	37
S202430.0100050050	100	50	50	50	76	44	30	37
S202430.0100050060	100	50	60	50	76	44	30	48

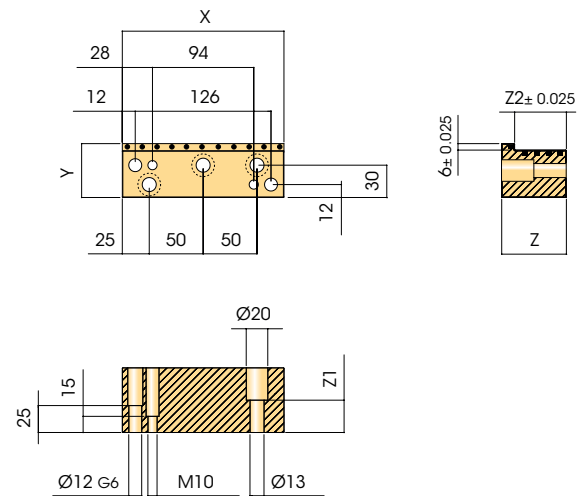

CODE	X	Y	Z	Z1	Z2
S202430.0150050037	150	50	37	15	25
S202430.0150050045	150	50	45	15	32

CODE	X	Y	Z	Z1	Z2
S202430.0150050050	150	50	50	30	37
S202430.0150050060	150	50	60	30	48



## S2 GUIDA ANGOLARE BRONZO AUTOLUBRIFICANTE

S2 ANGULAR GUIDE SELF-LUBRICATING

S2 WINKELLEISTE BRONZE MIT FESTCHMIERSTOFF

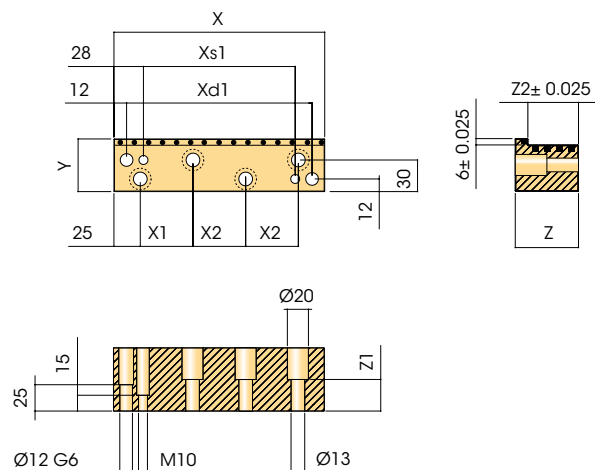

CODE	X	Y	Z	X1	X2	Xd1	Xs1	Z1	Z2
<a href="#">S202430.0200050037</a>	200	50	37	50	50	176	144	15	25
<a href="#">S202430.0200050045</a>	200	50	45	50	50	176	144	15	32
<a href="#">S202430.0200050050</a>	200	50	50	50	50	176	144	30	37
<a href="#">S202430.0200050060</a>	200	50	60	50	50	176	144	30	48
<a href="#">S202430.0250050060</a>	250	50	60	70	60	226	194	30	48

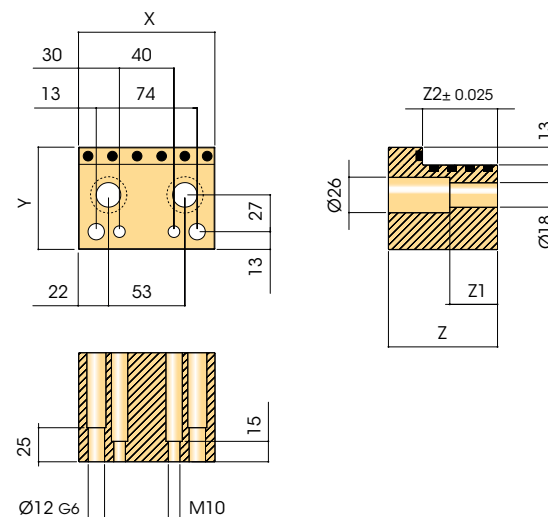

CODE	X	Y	Z	Z1	Z2
<a href="#">S202430.0100075050</a>	100	75	50	25	35
<a href="#">S202430.0100075060</a>	100	75	60	25	40
<a href="#">S202430.0100075070</a>	100	75	70	30	50

CODE	X	Y	Z	Z1	Z2
<a href="#">S202430.0100075080</a>	100	75	80	35	55
<a href="#">S202430.0100075090</a>	100	75	90	45	65
<a href="#">S202430.0100075100</a>	100	75	100	45	75

## S2 GUIDA ANGOLARE BRONZO AUTOLUBRIFICANTE

S2 ANGULAR GUIDE SELF-LUBRICATING

S2 WINKELLEISTE BRONZE MIT FESTCHMIERSTOFF

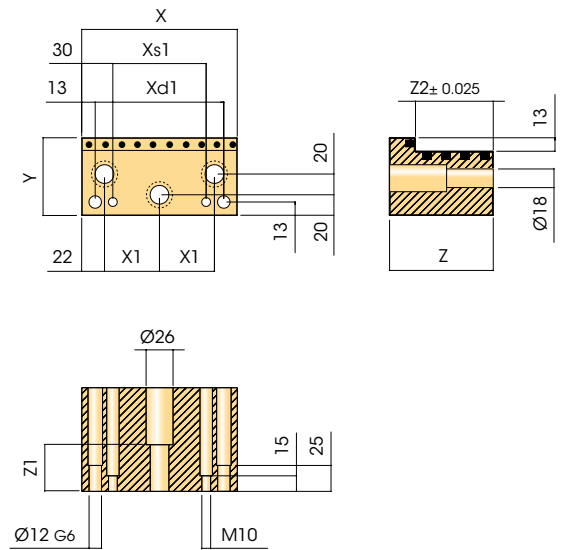

CODE	X	Y	Z	X1	Xd1	Xs1	Z1	Z2
<a href="#">S202430.0125075050</a>	125	75	50	40,5	99	65	25	35
<a href="#">S202430.0150075050</a>	150	75	50	53	124	90	25	35
<a href="#">S202430.0125075060</a>	125	75	60	40,5	99	65	25	40
<a href="#">S202430.0150075060</a>	150	75	60	53	124	90	25	40
<a href="#">S202430.0125075070</a>	125	75	70	40,5	99	65	30	50
<a href="#">S202430.0150075070</a>	150	75	70	53	124	90	30	50
<a href="#">S202430.0125075080</a>	125	75	80	40,5	99	65	35	55
<a href="#">S202430.0150075080</a>	150	75	80	53	124	90	35	55
<a href="#">S202430.0125075090</a>	125	75	90	40,5	99	65	45	65
<a href="#">S202430.0150075090</a>	150	75	90	53	124	90	45	65
<a href="#">S202430.0125075100</a>	125	75	100	40,5	99	65	45	75
<a href="#">S202430.0150075100</a>	150	75	100	53	124	90	45	75

## S2 GUIDA ANGOLARE BRONZO AUTOLUBRIFICANTE

S2 ANGULAR GUIDE SELF-LUBRICATING

S2 WINKELLEISTE BRONZE MIT FESTCHMIERSTOFF

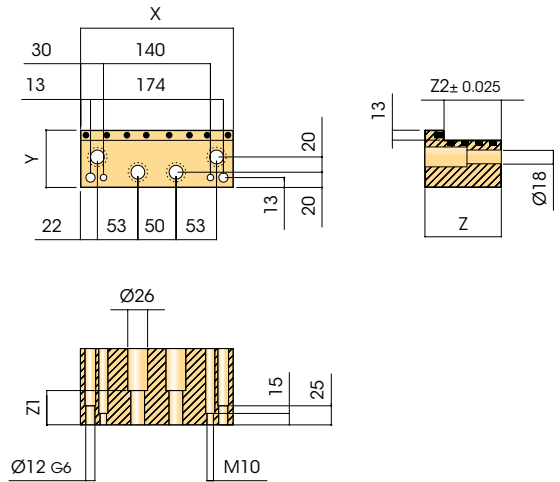

CODE	X	Y	Z	Z1	Z2
<a href="#">S202430.0200075050</a>	200	75	50	25	35
<a href="#">S202430.0200075060</a>	200	75	60	25	40
<a href="#">S202430.0200075070</a>	200	75	70	30	50

CODE	X	Y	Z	Z1	Z2
<a href="#">S202430.0200075080</a>	200	75	80	35	55
<a href="#">S202430.0200075090</a>	200	75	90	45	65
<a href="#">S202430.0200075100</a>	200	75	100	45	75

## S2 GUIDA ANGOLARE BRONZO AUTOLUBRIFICANTE

S2 ANGULAR GUIDE SELF-LUBRICATING

S2 WINKELLEISTE BRONZE MIT FESTCHMIERSTOFF

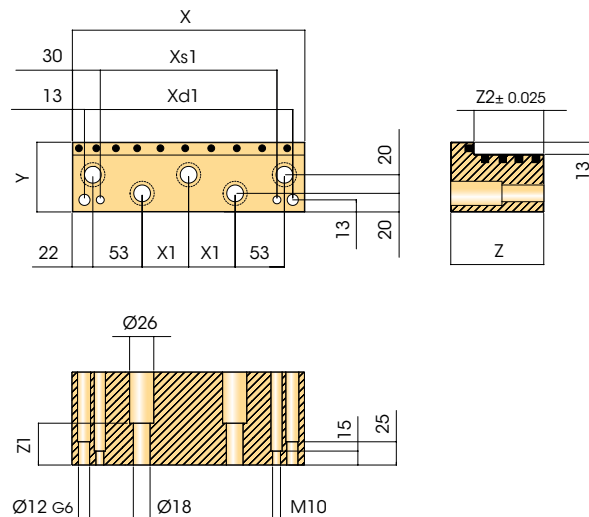
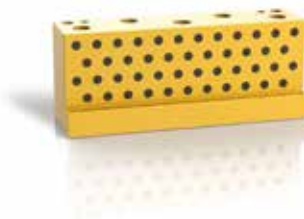

CODE	X	Y	Z	X1	Xd1	Xs1	Z1	Z2
S202430.0225075050	225	75	50	37,5	199	165	25	35
S202430.0250075050	250	75	50	53	224	190	25	35
S202430.0300075050	300	75	50	75	274	240	25	35
S202430.0225075060	225	75	60	37,5	199	165	25	40
S202430.0250075060	250	75	60	53	224	190	25	40
S202430.0300075060	300	75	60	75	274	240	25	40
S202430.0225075070	225	75	70	37,5	199	165	30	50
S202430.0250075070	250	75	70	53	224	190	30	50
S202430.0300075070	300	75	70	75	274	240	30	50
S202430.0225075080	225	75	80	37,5	199	165	35	55
S202430.0250075080	250	75	80	53	224	190	35	55
S202430.0300075080	300	75	80	75	274	240	35	55
S202430.0225075090	225	75	90	37,5	199	165	45	65
S202430.0250075090	250	75	90	53	224	190	45	65
S202430.0300075090	300	75	90	75	274	240	45	65
S202430.0225075100	225	75	100	37,5	199	165	45	75
S202430.0250075100	250	75	100	53	224	190	45	75
S202430.0300075100	300	75	100	75	274	240	45	75

## S2 GUIDA ANGOLARE BRONZO AUTOLUBRIFICANTE

S2 ANGULAR GUIDE SELF-LUBRICATING

S2 WINKELLEISTE BRONZE MIT FESTCHMIERSTOFF

### S2.024.31

NAAMS

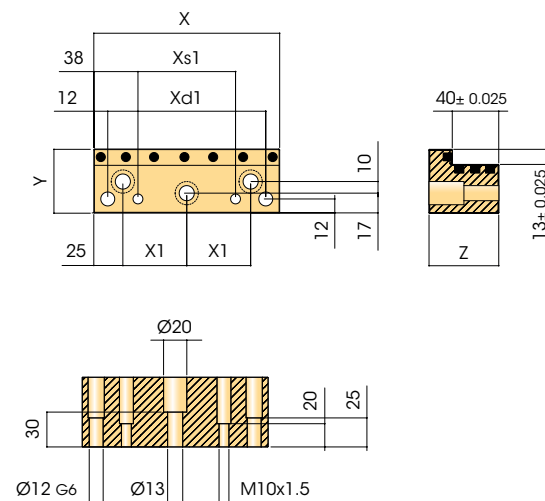

CODE	X	Y	Z	X1	Xd1	Xs1
S202431.0160055060	160	55	60	55	136	84
S202431.0200055060	200	55	60	75	176	124

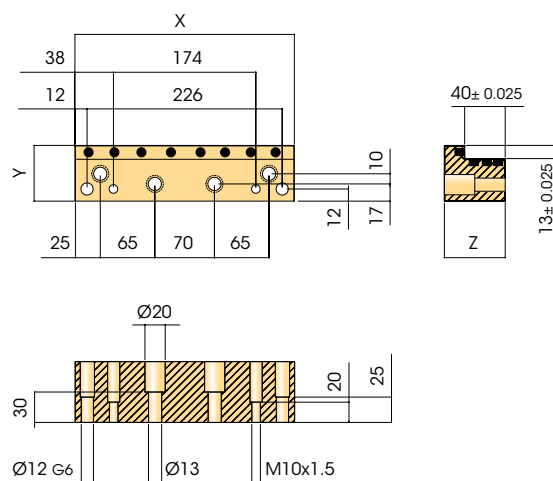

CODE	X	Y	Z
S202431.0250055060	250	55	60

## S2 GUIDA ANGOLARE BRONZO AUTOLUBRIFICANTE

S2 ANGULAR GUIDE SELF-LUBRICATING

S2 WINKELLEISTE BRONZE MIT FESTCHMIERSTOFF

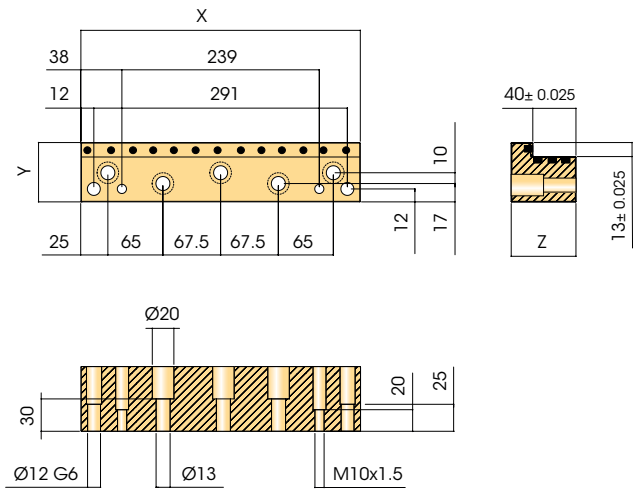

CODE	X	Y	Z
S202431.0315055060	315	55	60

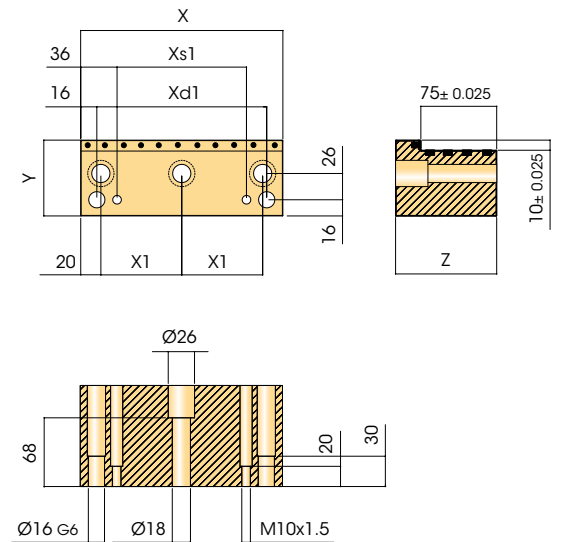

CODE	X	Y	Z	X1	Xd1	Xs1
S202431.0160075100	160	75	100	60	128	88
S202431.0200075100	200	75	100	80	168	128

## S2 GUIDA ANGOLARE BRONZO AUTOLUBRIFICANTE

S2 ANGULAR GUIDE SELF-LUBRICATING

S2 WINKELLEISTE BRONZE MIT FESTCHMIERSTOFF

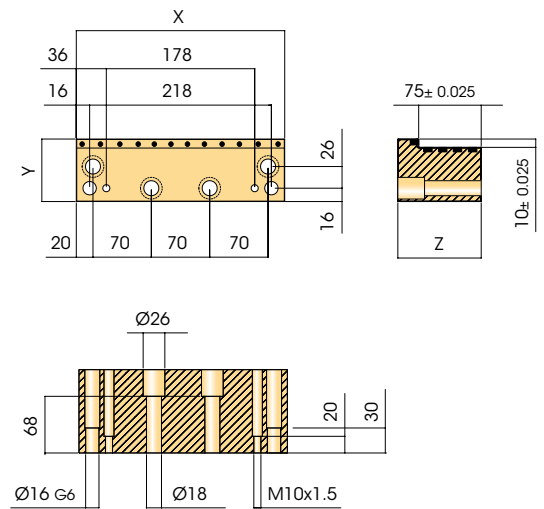

CODE	X	Y	Z
S202431.0250075100	250	75	100

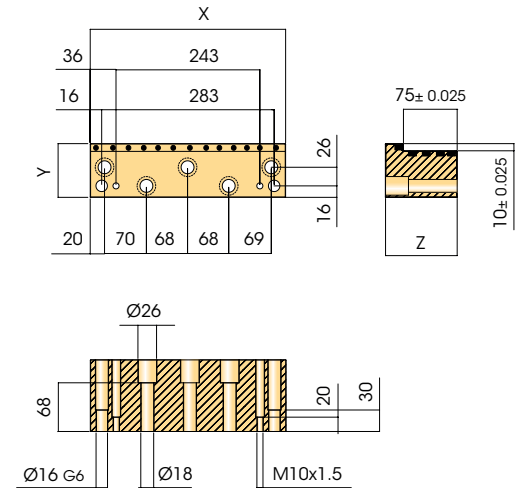

CODE	X	Y	Z
S202431.0315075100	315	75	100

## S2 GUIDA ANGOLARE BRONZO AUTOLUBRIFICANTE

S2 ANGULAR GUIDE SELF-LUBRICATING

S2 WINKELLEISTE BRONZE MIT FESTCHMIERSTOFF

### S2.026.10

FCA

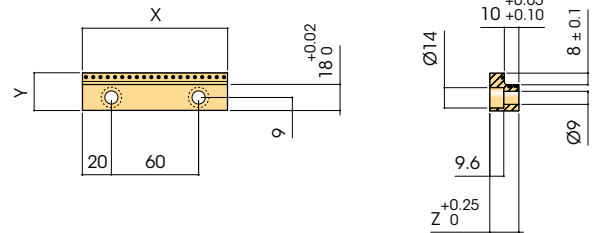

CODE	X	Y	Z
S202610.010002620	100	26	20

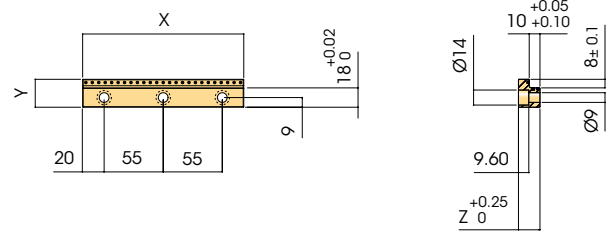
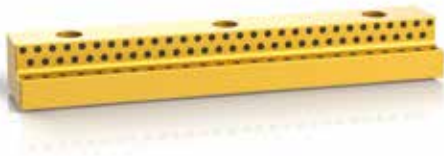

CODE	X	Y	Z
S202610.015002620	150	26	20

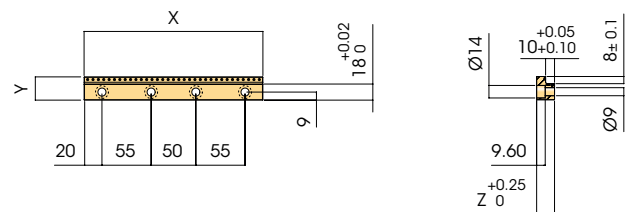

CODE	X	Y	Z
S202610.020002620	200	26	20



## S2 GUIDA ANGOLARE BRONZO AUTOLUBRIFICANTE

S2 ANGULAR GUIDE SELF-LUBRICATING

S2 WINKELLEISTE BRONZE MIT FESTSCHMIERSTOFF

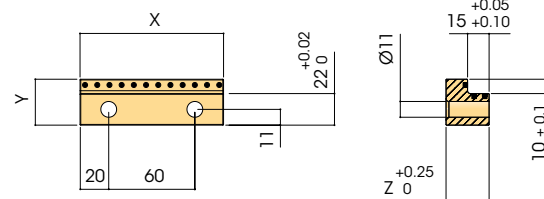

CODE	X	Y	Z
S202610.0100032030	100	32	30

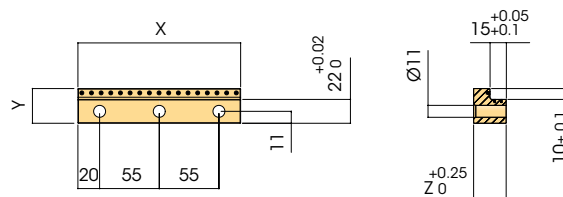

CODE	X	Y	Z
S202610.0150032030	150	32	30

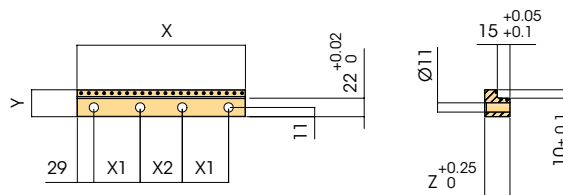

CODE	X	Y	Z	X1	X2
S202610.0200032030	200	32	30	55	50
S202610.0250032030	250	32	30	70	70

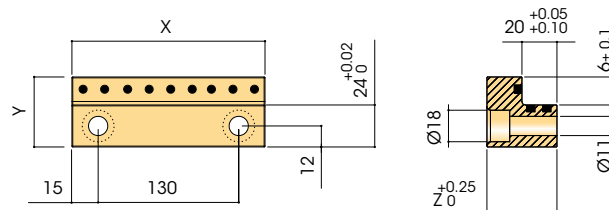

CODE	X	Y	Z
S202610.0160040040	160	40	40

## S2 GUIDA ANGOLARE BRONZO AUTOLUBRIFICANTE

S2 ANGULAR GUIDE SELF-LUBRICATING

S2 WINKELLEISTE BRONZE MIT FESTSCHMIERSTOFF

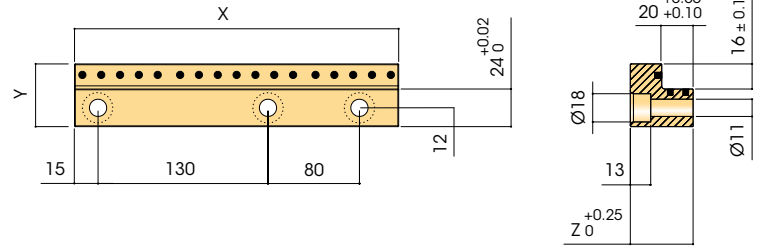

CODE	X	Y	Z
S202610.0250040040	250	40	40

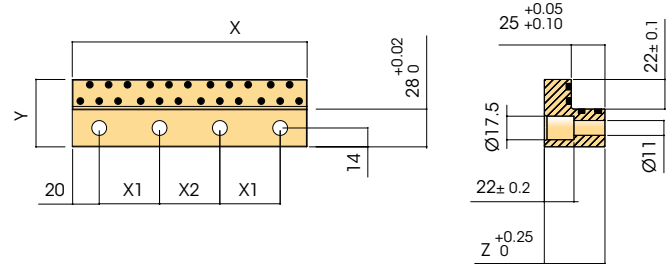

CODE	X	Y	Z	X1	X2
S202610.0200050045	200	50	45	55	50
S202610.0250050045	250	50	45	70	70

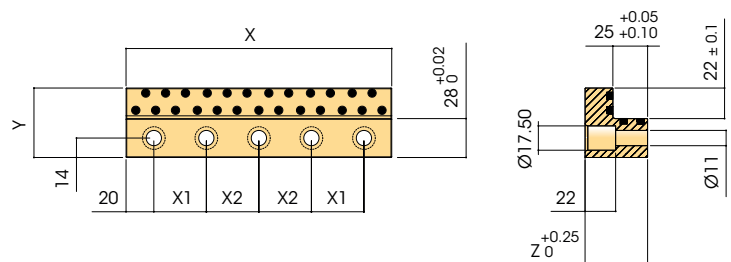

CODE	X	Y	Z	X1	X2
S202610.0300050045	300	50	45	65	65
S202610.0350050045	350	50	45	80	75

## S2 GUIDA ANGOLARE BRONZO AUTOLUBRIFICANTE

S2 ANGULAR GUIDE SELF-LUBRICATING

S2 WINKELLEISTE BRONZE MIT FESTCHMIERSTOFF

### S2.120.00

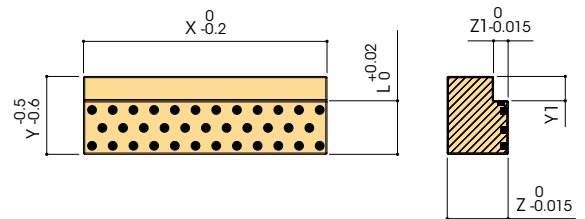

CODE	X	Y	Z	Y1	L	Z1
S212000.0050016016	50	16	16	8	8	5
S212000.0063016016	63	16	16	8	8	5
S212000.0080016016	80	16	16	8	8	5
S212000.0100016016	100	16	16	8	8	5
S212000.0063020020	63	20	20	8	12	5
S212000.0080020020	80	20	20	8	12	5
S212000.0100020020	100	20	20	8	12	5
S212000.0125020020	125	20	20	8	12	5
S212000.0080025020	80	25	20	8	17	5
S212000.0100025020	100	25	20	8	17	5
S212000.0125025020	125	25	20	8	17	5
S212000.0160025020	160	25	20	8	17	5
S212000.0100032025	100	32	25	10	22	6
S212000.0125032025	125	32	25	10	22	6
S212000.0160032025	160	32	25	10	22	6
S212000.0200032025	200	32	25	10	22	6
S212000.0125040025	125	40	25	10	30	6
S212000.0160040025	160	40	25	10	30	6
S212000.0200040025	200	40	25	10	30	6
S212000.0250040025	250	40	25	10	30	6
S212000.0160050032	160	50	32	12	40	8
S212000.0200050032	200	50	32	12	40	8
S212000.0250050032	250	50	32	12	40	8
S212000.0315050032	315	50	32	12	40	8

## S2 GUIDA ANGOLARE BRONZO AUTOLUBRIFICANTE

S2 ANGULAR GUIDE SELF-LUBRICATING

S2 WINKELLEISTE BRONZE MIT FESTCHMIERSTOFF

### S2.120.01

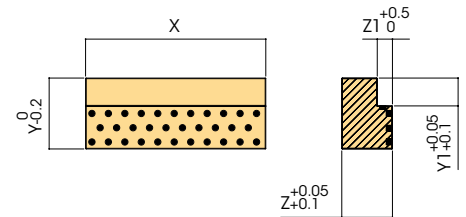

CODE	X	Y	Y	Y1	Z1
S212001.0205012015	205	12	15	5	5
S212001.0205017020	205	17	20	7	5
S212001.0320017020	320	17	20	7	5
S212001.0605017020	605	17	20	7	5
S212001.0205022020	205	22	20	7	5
S212001.0320022020	320	22	20	7	5
S212001.0605022020	605	22	20	7	5
S212001.0205027028	205	27	28	10	8
S212001.0320027028	320	27	28	10	8
S212001.0605027028	605	27	28	10	8
S212001.0205036028	205	36	28	10	8
S212001.0320036028	320	36	28	10	8
S212001.0605036028	605	36	28	10	8
S212001.0205046028	205	46	28	10	8

CODE	X	Y	Y	Y1	Z1
S212001.0320046028	320	46	28	10	8
S212001.0605046028	605	46	28	10	8
S212001.0205056040	205	56	40	22	12
S212001.0320056040	320	56	40	22	12
S212001.0605056040	605	56	40	22	12
S212001.0205066040	205	66	40	22	12
S212001.0320066040	320	66	40	22	12
S212001.0605066040	605	66	40	22	12
S212001.0205076040	205	76	40	26	12
S212001.0320076040	320	76	40	26	12
S212001.0605076040	605	76	40	26	12
S212001.0205086040	205	86	40	26	12
S212001.0320086040	320	86	40	26	12
S212001.0605086040	605	86	40	26	12

## S2 GUIDA ANGOLARE BRONZO AUTOLUBRIFICANTE

S2 ANGULAR GUIDE SELF-LUBRICATING

S2 WINKELLEISTE BRONZE MIT FESTCHMIERSTOFF

### S2.120.02

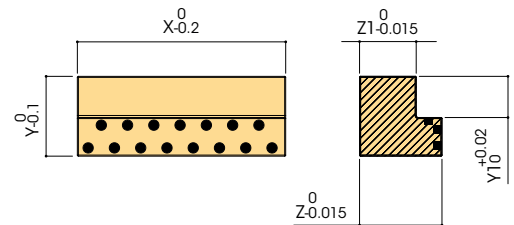

CODE	X	Y	Y	Y1	Z1
S212002.0040011016	40	11,5	16	6	12
S212002.0050011016	50	11,5	16	6	12
S212002.0063011016	63	11,5	16	6	12
S212002.0080011016	80	11,5	16	6	12
S212002.0050015016	50	15,5	16	8	11
S212002.0063015016	63	15,5	16	8	11
S212002.0080015016	80	15,5	16	8	11
S212002.0100015016	100	15,5	16	8	11
S212002.0063019020	63	19,5	20	8	15
S212002.0080019020	80	19,5	20	8	15
S212002.0100019020	100	19,5	20	8	15
S212002.0125019020	125	19,5	20	8	15
S212002.0080024020	80	24,5	20	8	15
S212002.0100024020	100	24,5	20	8	15

CODE	X	Y	Y	Y1	Z1
S212002.0125024020	125	24,5	20	8	15
S212002.0160024020	160	24,5	20	8	15
S212002.0100031025	100	31,5	25	10	19
S212002.0125031025	125	31,5	25	10	19
S212002.0160031025	160	31,5	25	10	19
S212002.0200031025	200	31,5	25	10	19
S212002.0125039025	125	39,5	25	10	19
S212002.0160039025	160	39,5	25	10	19
S212002.0200039025	200	39,5	25	10	19
S212002.0250039025	250	39,5	25	10	19
S212002.0160049032	160	49,5	32	12	24
S212002.0200049032	200	49,5	32	12	24
S212002.0250049032	250	49,5	32	12	24
S212002.0315049032	315	49,5	32	12	24

## S2 GUIDA ANGOLARE BRONZO AUTOLUBRIFICANTE

S2 ANGULAR GUIDE SELF-LUBRICATING

S2 WINKELLEISTE BRONZE MIT FESTSCHMIERSTOFF

### S2.120.30

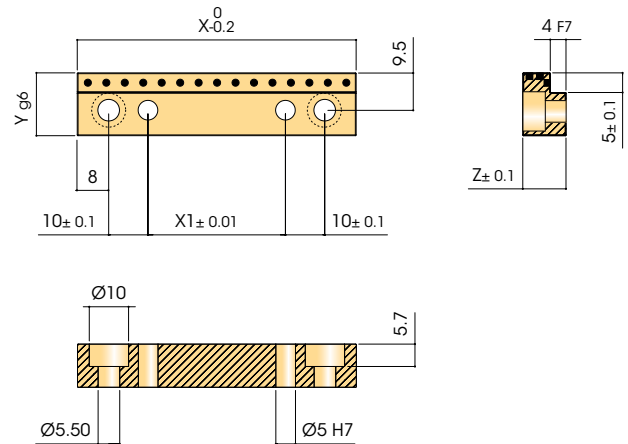

CODE	X	Y	Z	X1
S212030.0050016011	50	16	11	14
S212030.0071016011	71	16	11	35

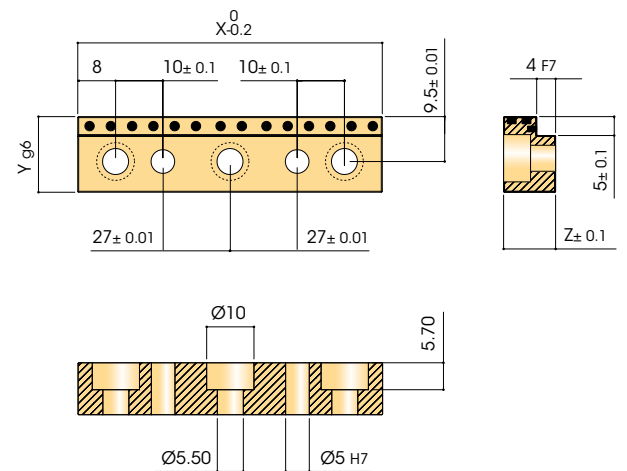

CODE	X	Y	Z
S212030.0090016011	90	16	11

## S2 GUIDA ANGOLARE BRONZO AUTOLUBRIFICANTE

S2 ANGULAR GUIDE SELF-LUBRICATING

S2 WINKELLEISTE BRONZE MIT FESTCHMIERSTOFF

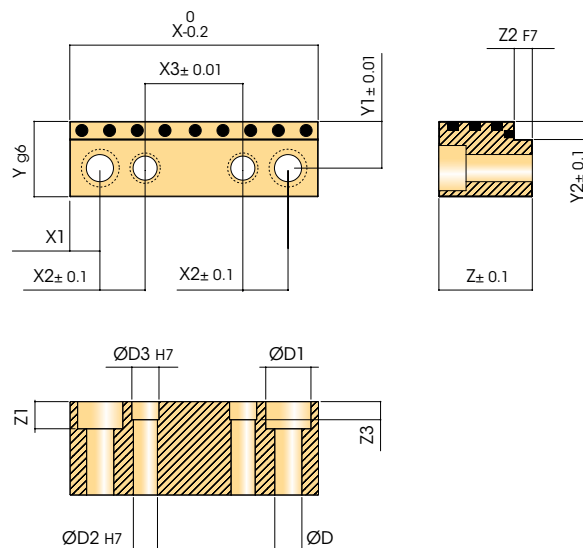

CODE	X	Y	Z	X1	X2	X3	Y1	Y2	Z1	Z2	Z3	D	D1	D2	D3
S212030.0080020019	80	20	19	8	12	40	12	5	6,8	5	9,5	6,6	11	6	7
S212030.0100020019	100	20	19	8	12	60	12	5	6,8	5	9,5	6,6	11	6	7
S212030.0100025031	100	25	31	10	15	50	15,5	6	9	6	19	9	15	8	9
S212030.0125025031	125	25	31	10	15	75	15,5	6	9	6	19	9	15	8	9
S212030.0125030049	125	30	49	15	20	55	18	7	11	8	34	11	18	10	12
S212030.0160030049	160	30	49	15	20	90	18	7	11	8	34	11	18	10	12

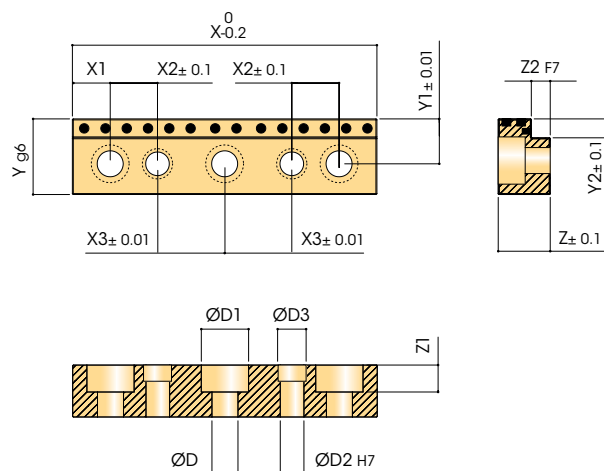

CODE	X	Y	Z	X1	X2	X3	Y1	Y2	Z1	Z2	Z3	D	D1	D2	D3
S212030.0125020019	125	20	19	8	12	42,5	12	5	6,8	5	9,5	6,6	11	6	7
S212030.0160025031	160	25	31	10	15	55	15,5	6	9	6	19	9	15	8	9
S212030.0200030049	200	30	49	15	20	65	18	7	11	8	34	11	18	10	12





# GUIDA T BRONZO AUTOLUBRIFICANTE S3

T-GUIDE SELF-LUBRICATING  
T-LISTE BRONZE MIT FESTCHMIERSTOFF

**MATERIAL** BRONZE with solid lubricant **HARDENESS** >190 HB

## S3 GUIDA T BRONZO AUTOLUBRIFICANTE

S3 T-GUIDE SELF-LUBRICATING

S3 T-LISTE BRONZE MIT FESTSCHMIERSTOFF

### S3.020.00

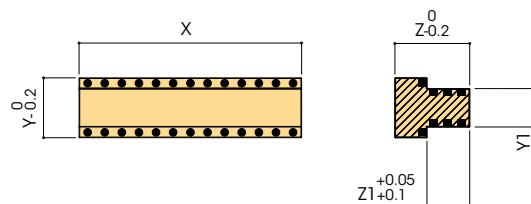
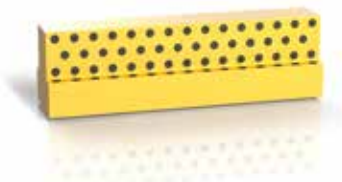

CODE	X	Y	Z	Y1	Z1
S302000.006001812	60	18	12	8	5
S302000.008001812	80	18	12	8	5
S302000.010001812	100	18	12	8	5
S302000.035001812	350	18	12	8	5
S302000.008002225	80	22	25	12	15
S302000.010002225	100	22	25	12	15
S302000.012002225	120	22	25	12	15

CODE	X	Y	Z	Y1	Z1
S302000.035002225	350	22	25	12	15
S302000.012002835	120	28	35	18	20
S302000.014002835	140	28	35	18	20
S302000.016002835	160	28	35	18	20
S302000.018002835	180	28	35	18	20
S302000.035002835	350	28	35	18	20

### S3.120.00

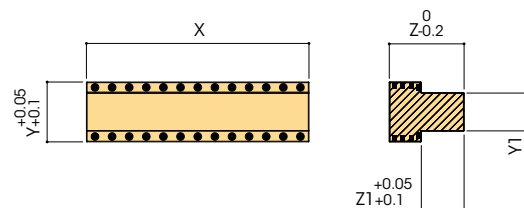

CODE	X	Y	Z	Y1	Z1
S312000.006001812	60	18	12	8	5
S312000.008001812	80	18	12	8	5
S312000.010001812	100	18	12	8	5
S312000.035001812	350	18	12	8	5
S312000.008002225	80	22	25	12	15
S312000.010002225	100	22	25	12	15
S312000.012002225	120	22	25	12	15

CODE	X	Y	Z	Y1	Z1
S312000.035002225	350	22	25	12	15
S312000.012002835	120	28	35	18	20
S312000.014002835	140	28	35	18	20
S312000.016002835	160	28	35	18	20
S312000.018002835	180	28	35	18	20
S312000.035002835	350	28	35	18	20

### S3 GUIDA T BRONZO AUTOLUBRIFICANTE

S3 T-GUIDE SELF-LUBRICATING

S3 T-LISTE BRONZE MIT FESTCHMIERSTOFF

## S3.120.10

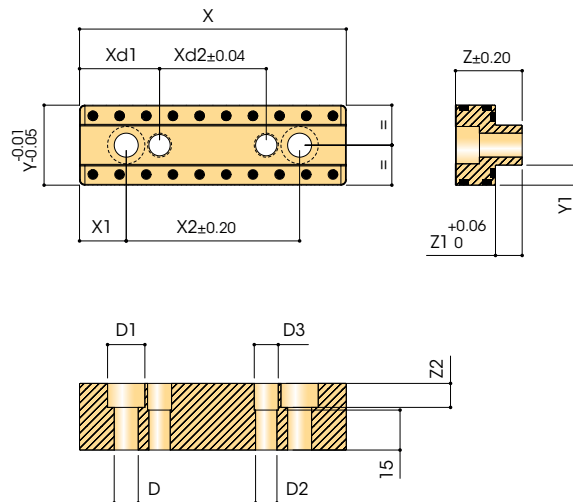

CODE	X	Y	Z	X1	X2	Xd1	Xd2	Y1	Z1	Z2	D	D1	D2	D3
S312010.006002015	60	20	15	12,5	35	22,5	15	4,5	8	6	5,5	9,5	6	7
S312010.008002015	80	20	15	12,5	55	22,5	35	4,5	8	6	5,5	9,5	6	7
S312010.010002015	100	20	15	12,5	75	22,5	55	4,5	8	6	5,5	9,5	6	7
S312010.008002520	80	25	20	15	50	30	20	5,5	8	7	6,5	11	6	7
S312010.010002520	100	25	20	15	70	30	40	5,5	8	7	6,5	11	6	7
S312010.010003025	100	30	25	17,5	65	30	40	7,5	10	9	9	14	8	9

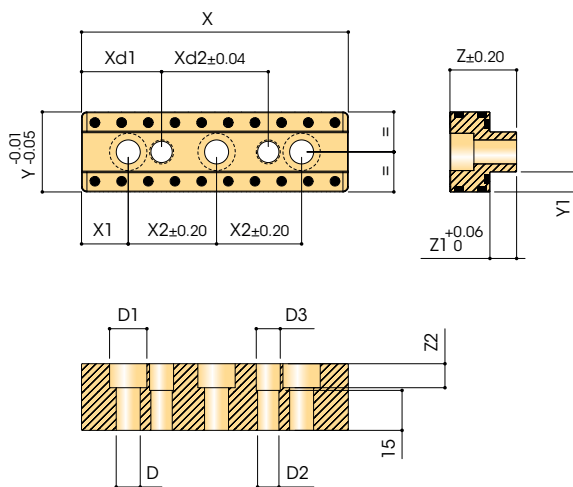

CODE	X	Y	Z	X1	X2	Xd1	Xd2	Y1	Z1	Z2	D	D1	D2	D3
S312010.012002520	120	25	20	15	45	30	60	5,5	8	7	6,5	11	6	7
S312010.012003025	120	30	25	17,5	42,5	30	60	7,5	10	9	9	14	8	9
S312010.014003025	140	30	25	17,5	52,5	30	80	7,5	10	9	9	14	8	9
S312010.012004030	120	40	30	20	40	40	40	11	15	11	11	18	8	9
S312010.014004030	140	40	30	20	50	40	60	11	15	11	11	18	8	9
S312010.016004030	160	40	30	20	60	40	80	11	15	11	11	18	8	9
S312010.018004030	180	40	30	20	70	40	100	11	15	11	11	18	8	9



# BUSSOLA BRONZO AUTOLUBRIFICANTE S4

BUSH SELF-LUBRIFICATING  
FÜHRUNGSBUCHSE

**MATERIAL** BRONZE with solid lubricant **HARDENESS** >190 HB

## S4 BUSSOLA BRONZO AUTOLUBRIFICANTE

S4 BUSH SELF-LUBRICATING

S4 FÜHRUNGSBUCHSE

# S4.100.00

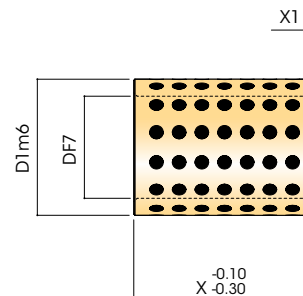

CODE	D	D1	X	X1
S410000.008011014	8	11	14	1
S410000.008011015	8	11	15	1
S410000.008012008	8	12	8	2
S410000.008012010	8	12	10	2
S410000.008012012	8	12	12	2
S410000.008012015	8	12	15	2
S410000.010014008	10	14	8	2
S410000.010014010	10	14	10	2
S410000.010014012	10	14	12	2
S410000.010014015	10	14	15	2
S410000.010014020	10	14	20	2
S410000.010015010	10	15	10	2
S410000.012016010	12	16	10	2
S410000.012016012	12	16	12	2
S410000.012016020	12	16	20	2
S410000.012018008	12	18	8	2
S410000.012018010	12	18	10	2
S410000.012018012	12	18	12	2
S410000.012018015	12	18	15	2
S410000.012018016	12	18	16	2
S410000.012018019	12	18	19	2
S410000.012018020	12	18	20	2
S410000.012018025	12	18	25	2
S410000.012018030	12	18	30	2
S410000.013019010	13	19	10	2
S410000.013019012	13	19	12	2
S410000.013019015	13	19	15	2
S410000.013019016	13	19	16	2
S410000.013019020	13	19	20	2
S410000.014020010	14	20	10	2

CODE	D	D1	X	X1
S410000.014020012	14	20	12	2
S410000.014020015	14	20	15	2
S410000.014020016	14	20	16	2
S410000.014020020	14	20	20	2
S410000.014020025	14	20	25	2
S410000.014020030	14	20	30	2
S410000.015021010	15	21	10	2
S410000.015021012	15	21	12	2
S410000.015021015	15	21	15	2
S410000.015021016	15	21	16	2
S410000.015021020	15	21	20	2
S410000.015021025	15	21	25	2
S410000.015021030	15	21	30	2
S410000.016020016	16	20	16	2
S410000.016020020	16	20	20	2
S410000.016020025	16	20	25	2
S410000.016020028	16	20	28	2
S410000.016022010	16	22	10	2
S410000.016022012	16	22	12	2
S410000.016022015	16	22	15	2
S410000.016022016	16	22	16	2
S410000.016022019	16	22	19	2
S410000.016022020	16	22	20	2
S410000.016022025	16	22	25	2
S410000.016022030	16	22	30	2
S410000.016022035	16	22	35	2
S410000.016022040	16	22	40	2
S410000.017023015	17	23	15	2
S410000.018022015	18	22	15	2
S410000.018022016	18	22	16	2

## S4 BUSSOLA BRONZO AUTOLUBRIFICANTE

S4 BUSH SELF-LUBRICATING

S4 FÜHRUNGSBUCHSE

CODE	D	D1	X	X1
S410000.018024012	18	24	12	2
S410000.018024015	18	24	15	2
S410000.018024016	18	24	16	2
S410000.018024018	18	24	18	2
S410000.018024020	18	24	20	2
S410000.018024025	18	24	25	2
S410000.018024030	18	24	30	2
S410000.018024035	18	24	35	2
S410000.018024040	18	24	40	2
S410000.019025037	19	25	37	2
S410000.019026015	19	26	15	2
S410000.019026020	19	26	20	2
S410000.020026015	20	26	15	3
S410000.020026020	20	26	20	3
S410000.020026025	20	26	25	3
S410000.020026030	20	26	30	3
S410000.020026040	20	26	40	3
S410000.020028010	20	28	10	4
S410000.020028012	20	28	12	4
S410000.020028015	20	28	15	4
S410000.020028016	20	28	16	4
S410000.020028019	20	28	19	4
S410000.020028020	20	28	20	4
S410000.020028025	20	28	25	4
S410000.020028030	20	28	30	4
S410000.020028035	20	28	35	4
S410000.020028037	20	28	37	4
S410000.020028040	20	28	40	4
S410000.020028050	20	28	50	4
S410000.020030016	20	30	16	4
S410000.020030020	20	30	20	4
S410000.020030025	20	30	25	4
S410000.020030030	20	30	30	4
S410000.020030035	20	30	35	4
S410000.020030040	20	30	40	4
S410000.020030050	20	30	50	4
S410000.022032012	22	32	12	4
S410000.022032015	22	32	15	4
S410000.022032020	22	32	20	4
S410000.022032025	22	32	25	4
S410000.024032047	24	32	47	4
S410000.025030020	25	30	20	3
S410000.025032050	25	32	50	4
S410000.025033012	25	33	12	4
S410000.025033015	25	33	15	4

CODE	D	D1	X	X1
S410000.025033016	25	33	16	4
S410000.025033020	25	33	20	4
S410000.025033025	25	33	25	4
S410000.025033030	25	33	30	4
S410000.025033035	25	33	35	4
S410000.025033040	25	33	40	4
S410000.025033047	25	33	47	4
S410000.025033050	25	33	50	4
S410000.025033060	25	33	60	4
S410000.025035012	25	35	12	4
S410000.025035015	25	35	15	4
S410000.025035016	25	35	16	4
S410000.025035020	25	35	20	4
S410000.025035025	25	35	25	4
S410000.025035030	25	35	30	4
S410000.025035035	25	35	35	4
S410000.025035040	25	35	40	4
S410000.025035050	25	35	50	4
S410000.025035060	25	35	60	4
S410000.028038020	28	38	20	4
S410000.028038025	28	38	25	4
S410000.028038030	28	38	30	4
S410000.028038040	28	38	40	4
S410000.030038012	30	38	12	4
S410000.030038015	30	38	15	4
S410000.030038020	30	38	20	4
S410000.030038025	30	38	25	4
S410000.030038030	30	38	30	4
S410000.030038035	30	38	35	4
S410000.030038040	30	38	40	4
S410000.030038045	30	38	45	4
S410000.030038050	30	38	50	4
S410000.030038060	30	38	60	4
S410000.030040012	30	40	12	4
S410000.030040015	30	40	15	4
S410000.030040020	30	40	20	4
S410000.030040025	30	40	25	4
S410000.030040030	30	40	30	4
S410000.030040035	30	40	35	4
S410000.030040040	30	40	40	4
S410000.030040050	30	40	50	4
S410000.030040060	30	40	60	4
S410000.030042060	30	42	60	4
S410000.030045040	30	45	40	4
S410000.031040030	31,5	40	30	4

## S4 BUSSOLA BRONZO AUTOLUBRIFICANTE

S4 BUSH SELF-LUBRICATING

S4 FÜHRUNGSBUCHSE

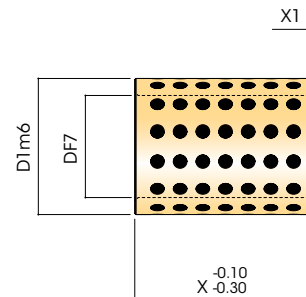

CODE	D	D1	X	X1
S410000.031040040	31,5	40	40	4
S410000.032042020	32	42	20	4
S410000.032042030	32	42	30	4
S410000.032042040	32	42	40	4
S410000.032042060	32	42	60	4
S410000.035044020	35	44	20	4
S410000.035044025	35	44	25	4
S410000.035044030	35	44	30	4
S410000.035044035	35	44	35	4
S410000.035044040	35	44	40	4
S410000.035044050	35	44	50	4
S410000.035044060	35	44	60	4
S410000.035045020	35	45	20	4
S410000.035045025	35	45	25	4
S410000.035045030	35	45	30	4
S410000.035045035	35	45	35	4
S410000.035045040	35	45	40	4
S410000.035045045	35	45	45	4
S410000.035045050	35	45	50	4
S410000.035045060	35	45	60	4
S410000.035045100	35	45	100	4
S410000.036045115	36	45	115	4
S410000.036045145	36	45	145	4
S410000.036045170	36	45	170	4
S410000.038048030	38	48	30	4
S410000.038048040	38	48	40	4
S410000.038048077	38	48	77	4
S410000.040050015	40	50	15	4
S410000.040050020	40	50	20	4
S410000.040050025	40	50	25	4
S410000.040050030	40	50	30	4
S410000.040050035	40	50	35	4
S410000.040050040	40	50	40	4
S410000.040050050	40	50	50	4
S410000.040050060	40	50	60	4

CODE	D	D1	X	X1
S410000.040050070	40	50	70	4
S410000.040050077	40	50	77	4
S410000.040050080	40	50	80	4
S410000.040055015	40	55	15	4
S410000.040055025	40	55	25	4
S410000.040055030	40	55	30	4
S410000.040055035	40	55	35	4
S410000.040055040	40	55	40	4
S410000.040055050	40	55	50	4
S410000.040055060	40	55	60	4
S410000.045055030	45	55	30	4
S410000.045055035	45	55	35	4
S410000.045055040	45	55	40	4
S410000.045055050	45	55	50	4
S410000.045055060	45	55	60	4
S410000.045055110	45	55	110	4
S410000.045056012	45	56	12	4
S410000.045056030	45	56	30	4
S410000.045056035	45	56	35	4
S410000.045056040	45	56	40	4
S410000.045056050	45	56	50	4
S410000.045056060	45	56	60	4
S410000.045060030	45	60	30	4
S410000.045060035	45	60	35	4
S410000.045060040	45	60	40	4
S410000.045060050	45	60	50	4
S410000.045060060	45	60	60	4
S410000.045060070	45	60	70	4
S410000.045060080	45	60	80	4
S410000.050060020	50	60	20	4
S410000.050060030	50	60	30	4
S410000.050060035	50	60	35	4
S410000.050060040	50	60	40	4
S410000.050060050	50	60	50	4
S410000.050060060	50	60	60	4



## S4 BUSSOLA BRONZO AUTOLUBRIFICANTE

S4 BUSH SELF-LUBRICATING

S4 FÜHRUNGSBUCHSE

CODE	D	D1	X	X1
S410000.050060070	50	60	70	4
S410000.050060080	50	60	80	4
S410000.050060095	50	60	95	4
S410000.050062030	50	62	30	4
S410000.050062035	50	62	35	4
S410000.050062040	50	62	40	4
S410000.050062050	50	62	50	4
S410000.050062060	50	62	60	4
S410000.050062070	50	62	70	4
S410000.050062080	50	62	80	4
S410000.050065030	50	65	30	4
S410000.050065040	50	65	40	4
S410000.050065050	50	65	50	4
S410000.050065060	50	65	60	4
S410000.050065070	50	65	70	4
S410000.050065080	50	65	80	4
S410000.050065100	50	65	100	4
S410000.055070030	55	70	30	4
S410000.055070035	55	70	35	4
S410000.055070040	55	70	40	4
S410000.055070050	55	70	50	4
S410000.055070060	55	70	60	4
S410000.055070070	55	70	70	4
S410000.060070050	60	70	50	4
S410000.060074030	60	74	30	4
S410000.060074035	60	74	35	4
S410000.060074040	60	74	40	4
S410000.060074045	60	74	45	4
S410000.060074050	60	74	50	4
S410000.060074060	60	74	60	4
S410000.060074070	60	74	70	4
S410000.060074080	60	74	80	4
S410000.060074100	60	74	100	4
S410000.060075030	60	75	30	4
S410000.060075035	60	75	35	4
S410000.060075040	60	75	40	4
S410000.060075050	60	75	50	4
S410000.060075060	60	75	60	4
S410000.060075070	60	75	70	4
S410000.060075080	60	75	80	4
S410000.060075100	60	75	100	4
S410000.063075060	63	75	60	4
S410000.063075070	63	75	70	4
S410000.063075080	63	75	80	4
S410000.063075120	63	75	120	4

CODE	D	D1	X	X1
S410000.065080040	65	80	40	4
S410000.065080050	65	80	50	4
S410000.065080060	65	80	60	4
S410000.065080070	65	80	70	4
S410000.065080080	65	80	80	4
S410000.070085030	70	85	30	4
S410000.070085035	70	85	35	4
S410000.070085040	70	85	40	4
S410000.070085050	70	85	50	4
S410000.070085060	70	85	60	4
S410000.070085070	70	85	70	4
S410000.070085080	70	85	80	4
S410000.070085100	70	85	100	4
S410000.070090040	70	90	40	4
S410000.070090050	70	90	50	4
S410000.070090060	70	90	60	4
S410000.070090070	70	90	70	4
S410000.070090080	70	90	80	4
S410000.070090100	70	90	100	4
S410000.075090050	75	90	50	4
S410000.075090060	75	90	60	4
S410000.075090070	75	90	70	4
S410000.075090080	75	90	80	4
S410000.075090100	75	90	100	4
S410000.075095060	75	95	60	4
S410000.075095070	75	95	70	4
S410000.075095080	75	95	80	4
S410000.075095100	75	95	100	4
S410000.080096040	80	96	40	4
S410000.080096050	80	96	50	4
S410000.080096060	80	96	60	4
S410000.080096070	80	96	70	4
S410000.080096080	80	96	80	4
S410000.080096100	80	96	100	4
S410000.080096120	80	96	120	4
S410000.080100040	80	100	40	4
S410000.080100050	80	100	50	4
S410000.080100060	80	100	60	4
S410000.080100070	80	100	70	4
S410000.080100080	80	100	80	4
S410000.080100100	80	100	100	4
S410000.080100120	80	100	120	4
S410000.080100140	80	100	140	4
S410000.085100060	85	100	60	4
S410000.085100080	85	100	80	4

## S4 BUSSOLA BRONZO AUTOLUBRIFICANTE

S4 BUSH SELF-LUBRICATING

S4 FÜHRUNGSBUCHSE

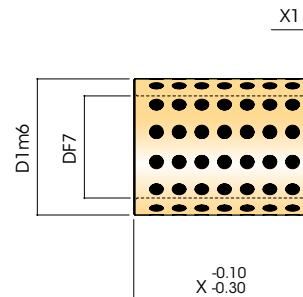

CODE	D	D1	X	X1
S410000.090110030	90	110	30	4
S410000.090110050	90	110	50	4
S410000.090110060	90	110	60	4
S410000.090110070	90	110	70	4
S410000.090110080	90	110	80	4
S410000.090110090	90	110	90	4
S410000.090110100	90	110	100	4
S410000.090110120	90	110	120	4
S410000.100120050	100	120	50	4
S410000.100120060	100	120	60	4
S410000.100120070	100	120	70	4
S410000.100120080	100	120	80	4
S410000.100120100	100	120	100	4
S410000.100120120	100	120	120	4
S410000.100120140	100	120	140	4
S410000.100125125	100	125	125	4
S410000.110130050	110	130	50	4
S410000.110130070	110	130	70	4
S410000.110130080	110	130	80	4
S410000.110130100	110	130	100	4
S410000.110130120	110	130	120	4

CODE	D	D1	X	X1
S410000.120140070	120	140	70	4
S410000.120140080	120	140	80	4
S410000.120140090	120	140	90	4
S410000.120140100	120	140	100	4
S410000.120140120	120	140	120	4
S410000.120140140	120	140	140	4
S410000.125145100	125	145	100	4
S410000.125145120	125	145	120	4
S410000.130150080	130	150	80	4
S410000.130150100	130	150	100	4
S410000.130150120	130	150	120	4
S410000.130150130	130	150	130	4
S410000.140160100	140	160	100	4
S410000.140160140	140	160	140	4
S410000.150170080	150	170	80	4
S410000.150170100	150	170	100	4
S410000.150170150	150	170	150	4
S410000.160180080	160	180	80	4
S410000.160180100	160	180	100	4
S410000.160180150	160	180	150	4

## S4 BUSSOLA BRONZO AUTOLUBRIFICANTE

S4 BUSH SELF-LUBRICATING

S4 FÜHRUNGSBUCHSE

### S4.110.00

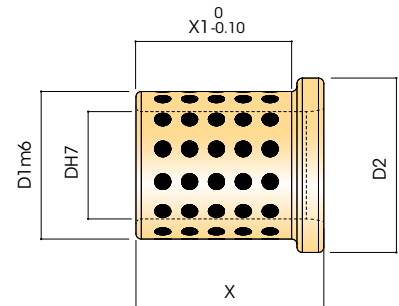

CODE	D	D1	X	D2	X1
S411000.025035040	25	35	40	45	33
S411000.030040050	30	40	50	50	40
S411000.040055070	40	55	70	65	60
S411000.050065080	50	65	80	75	70
S411000.060075080	60	75	80	85	70
S411000.065080080	65	80	80	90	70

CODE	D	D1	X	D2	X1
S411000.065080120	65	80	120	90	110
S411000.080100100	80	100	100	110	90
S411000.080100140	80	100	140	110	130
S411000.100120100	100	120	100	130	90
S411000.100120140	100	120	140	130	130

## S4 BUSSOLA BRONZO AUTOLUBRIFICANTE

S4 BUSH SELF-LUBRICATING

S4 FÜHRUNGSBUCHSE

### S4.110.01

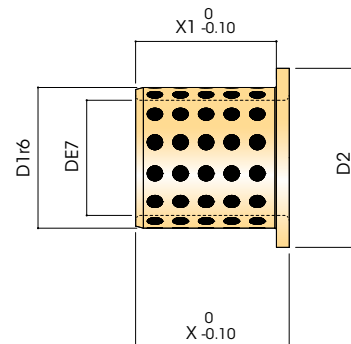

CODE	D	D1	X	D2	X1
S411001.008012010	8	12	10	20	8
S411001.008012015	8	12	15	20	13
S411001.010014012	10	14	12	22	10
S411001.010014015	10	14	15	22	13
S411001.010014017	10	14	17	22	15
S411001.010014020	10	14	20	22	18
S411001.012018015	12	18	15	25	12
S411001.012018020	12	18	20	25	17
S411001.012018025	12	18	25	25	22
S411001.012018030	12	18	30	25	27
S411001.013019015	13	19	15	26	12
S411001.013019020	13	19	20	26	17
S411001.014020015	14	20	15	27	12
S411001.014020020	14	20	20	27	17
S411001.014020025	14	20	25	27	22
S411001.015021015	15	21	15	28	12
S411001.015021020	15	21	20	28	17
S411001.015021025	15	21	25	28	22
S411001.015021030	15	21	30	28	27
S411001.016022015	16	22	15	29	12
S411001.016022018	16	22	18	29	15
S411001.016022020	16	22	20	29	17
S411001.016022023	16	22	23	29	20
S411001.016022025	16	22	25	29	22
S411001.016022030	16	22	30	29	27
S411001.016022035	16	22	35	29	32
S411001.016022040	16	22	40	29	37
S411001.018024020	18	24	20	32	17
S411001.018024030	18	24	30	32	27
S411001.020030015	20	30	15	40	10

CODE	D	D1	X	D2	X1
S411001.020030020	20	30	20	40	15
S411001.020030025	20	30	25	40	20
S411001.020030030	20	30	30	40	25
S411001.020030035	20	30	35	40	30
S411001.020030040	20	30	40	40	35
S411001.025035015	25	35	15	45	10
S411001.025035020	25	35	20	45	15
S411001.025035025	25	35	25	45	20
S411001.025035030	25	35	30	45	25
S411001.025035035	25	35	35	45	30
S411001.025035040	25	35	40	45	35
S411001.025035050	25	35	50	45	45
S411001.030040020	30	40	20	50	15
S411001.030040025	30	40	25	50	20
S411001.030040030	30	40	30	50	25
S411001.030040035	30	40	35	50	30
S411001.030040040	30	40	40	50	35
S411001.030040050	30	40	50	50	45
S411001.031040020	31,5	40	20	50	15
S411001.031040035	31,5	40	35	50	30
S411001.031040040	31,5	40	40	50	35
S411001.035045020	35	45	20	60	15
S411001.035045025	35	45	25	60	20
S411001.035045030	35	45	30	60	25
S411001.035045035	35	45	35	60	30
S411001.035045040	35	45	40	60	35
S411001.035045050	35	45	50	60	45
S411001.040050020	40	50	20	65	15
S411001.040050025	40	50	25	65	20
S411001.040050030	40	50	30	65	25

## S4 BUSSOLA BRONZO AUTOLUBRIFICANTE

S4 BUSH SELF-LUBRICATING

S4 FÜHRUNGSBUCHSE

CODE	D	D1	X	D2	X1
S411001.040050035	40	50	35	65	30
S411001.040050040	40	50	40	65	35
S411001.040050050	40	50	50	65	45
S411001.045055030	45	55	30	70	25
S411001.045055035	45	55	35	70	30
S411001.045055040	45	55	40	70	35
S411001.045055050	45	55	50	70	45
S411001.045055060	45	55	60	70	55
S411001.050060030	50	60	30	75	25
S411001.050060035	50	60	35	75	30
S411001.050060040	50	60	40	75	35
S411001.050060050	50	60	50	75	45
S411001.050060060	50	60	60	75	55
S411001.055065040	55	65	40	80	35
S411001.055065060	55	65	60	80	55
S411001.060075040	60	75	40	90	32,5

CODE	D	D1	X	D2	X1
S411001.060075050	60	75	50	90	42,5
S411001.060075080	60	75	80	90	72,5
S411001.063075067	63	75	67,5	85	60
S411001.070085050	70	85	50	105	42,5
S411001.070085080	70	85	80	105	72,5
S411001.075090060	75	90	60	110	52,5
S411001.080100060	80	100	60	120	50
S411001.080100080	80	100	80	120	70
S411001.080100100	80	100	100	120	90
S411001.090110060	90	110	60	130	50
S411001.090110080	90	110	80	130	70
S411001.100120080	100	120	80	150	70
S411001.100120100	100	120	100	150	90
S411001.120140080	120	140	80	170	70
S411001.120140100	120	140	100	170	90

## S4.110.02

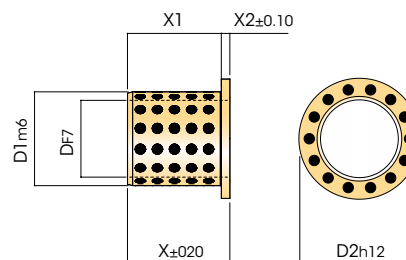

CODE	D	D1	X	D2	X1	X2
S411002.012018015	12	18	15	25	11	4
S411002.016022020	16	22	20	30	15	5
S411002.020028025	20	28	25	36	20	5
S411002.025033030	25	33	30	43	25	5
S411002.030038035	30	38	35	48	30	5
S411002.040050045	40	50	45	60	40	5
S411002.050060050	50	60	50	68	45	5
S411002.050062055	50	62	55	75	49	6
S411002.060075060	60	75	60	83	52,5	7,5
S411002.060075065	60	75	65	90	58	7

## S4 BUSSOLA BRONZO AUTOLUBRIFICANTE

S4 BUSH SELF-LUBRICATING

S4 FÜHRUNGSBUCHSE

### S4.110.03

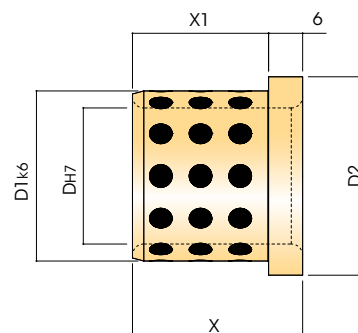

CODE	D	D1	X	D2	X1
S411003.012016020	12	16	20	18	14
S411003.012016025	12	16	25	18	19
S411003.012016030	12	16	30	18	24
S411003.016020020	16	20	20	24	14
S411003.016020025	16	20	25	24	19
S411003.016020030	16	20	30	24	24

CODE	D	D1	X	D2	X1
S411003.020026020	20	26	20	28	14
S411003.020026025	20	26	25	28	19
S411003.020026030	20	26	30	28	24
S411003.024030020	24	30	20	35	14
S411003.024030025	24	30	25	35	19
S411003.024030030	24	30	30	35	24

### S4.110.10

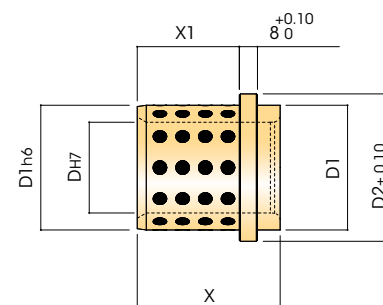

CODE	D	D1	X	D2	X1
S411010.025032040	25	32	40	40	28
S411010.030045050	30	45	50	55	32
S411010.032045050	32	45	50	55	32
S411010.038055063	38	55	63	65	45
S411010.040055063	40	55	63	65	45
S411010.048063072	48	63	72	75	54
S411010.050063072	50	63	72	75	54

CODE	D	D1	X	D2	X1
S411010.060080080	60	80	80	95	62
S411010.063080080	63	80	80	95	62
S411010.078100100	78	100	100	120	82
S411010.080100100	80	100	100	120	82
S411010.098125125	98	125	125	145	107
S411010.100125125	100	125	125	145	107

## S4 BUSSOLA BRONZO AUTOLUBRIFICANTE

S4 BUSH SELF-LUBRICATING

S4 FÜHRUNGSBUCHSE

### S4.112.10

ISO 9448-10E

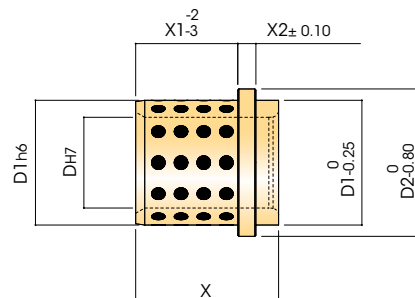

CODE	D	D1	X	D2	X1	X2
S411210.024032040	24	32	40	40	30	6,3
S411210.025032032	25	32	32	40	22	6,3
S411210.025032040	25	32	40	40	30	6,3
S411210.030040050	30	40	50	50	38	6,3
S411210.032040050	32	40	50	50	38	6,3
S411210.038050063	38	50	63	63	48	6,3
S411210.040050063	40	50	63	63	48	6,3
S411210.042050063	42	50	63	63	48	6,3
S411210.048063071	48	63	71	71	54	6,3
S411210.050063071	50	63	71	71	54	6,3
S411210.052063071	52	63	71	71	54	6,3
S411210.060080080	60	80	80	90	61	10
S411210.063080080	63	80	80	90	61	10
S411210.080100100	80	100	100	112	78	10
S411210.100125125	100	125	125	140	104	10
S411210.125160160	125	160	160	180	130	10
S411210.160200200	160	200	200	220	168	10

## S4 BUSSOLA BRONZO AUTOLUBRIFICANTE

S4 BUSH SELF-LUBRICATING

S4 FÜHRUNGSBUCHSE

### S4.113.10

VDI 3356

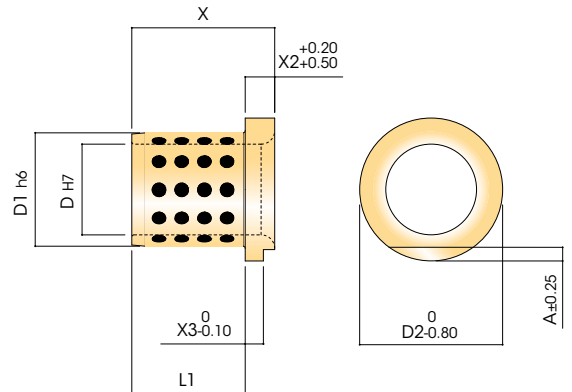

CODE	D	D1	X	D2	X1	X2	X3	A
S411310.016025025	16	25	25	32	15	10	5	3
S411310.020025032	20	25	32	32	22	10	5	3
S411310.025032032	25	32	32	40	22	10	5	3,5
S411310.032040050	32	40	50	50	40	10	5	4
S411310.040050063	40	50	63	63	50	13	8	5
S411310.050063072	50	63	72	75	58	14	8	6
S411310.063080080	63	80	80	95	63	17	10	8
S411310.080100100	80	100	100	120	80	20	10	10
S411310.100125125	100	125	125	150	100	25	16	13
S411310.125160160	125	160	160	190	130	30	16	13
S411310.140180180	140	180	180	210	150	30	16	13
S411310.160200200	160	200	200	240	170	30	16	13



## S4 BUSSOLA BRONZO AUTOLUBRIFICANTE

S4 BUSH SELF-LUBRICATING

S4 FÜHRUNGSBUCHSE

### S4.114.00

NAAMS

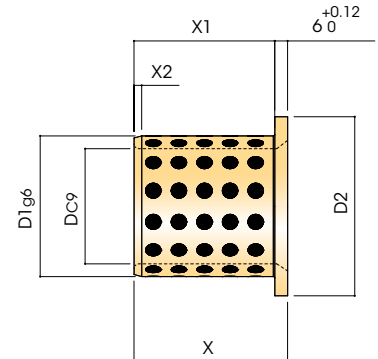

CODE	D	D1	X	D2	X1
S411400.025032040	25	32	40	40	34
S411400.032040050	32	40	50	50	44
S411400.040050055	40	50	55	63	49
S411400.050063063	50	63	63	71	57

CODE	D	D1	X	D2	X1
S411400.063080075	63	80	75	90	69
S411400.080100090	80	100	90	112	84
S411400.100125115	100	125	115	140	109
S411400.125160138	125	160	138	180	132

### S4.114.10

NAAMS

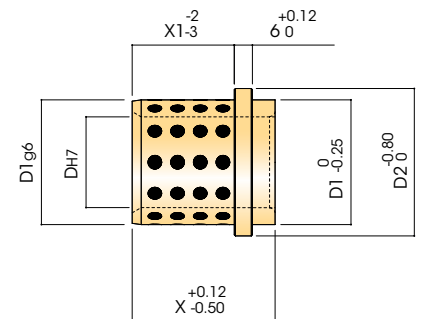

CODE	D	D1	X	D2	D3	X1
S411410.025032040	25	32	40	32	40	30
S411410.032040050	32	40	50	40	50	40
S411410.040050063	40	50	63	50	63	50
S411410.050063071	50	63	71	63	71	56
S411410.063080080	63	80	80	80	90	63
S411410.080100100	80	100	100	100	112	80
S411410.100125125	100	125	125	125	140	106
S411410.115140140	115	140	140	140	155	120
S411410.125160160	125	160	160	160	180	132

## S4 BUSSOLA BRONZO AUTOLUBRIFICANTE

S4 BUSH SELF-LUBRICATING

S4 FÜHRUNGSBUCHSE

### S4.115.00

AFNOR

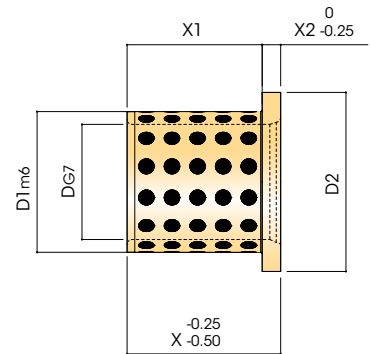

CODE	D	D1	X	D2	X1	X2
S411500.020028032	20	28	32	32	28	4
S411500.025035040	25	35	40	40	35	5
S411500.032044050	32	44	50	50	44	6
S411500.040052063	40	52	63	60	55	8
S411500.050063080	50	63	80	71	70	10
S411500.063080100	63	80	100	90	88	12
S411500.080100125	80	100	125	112	109	16
S411500.100125160	100	125	160	140	140	20

## S4 BUSSOLA BRONZO AUTOLUBRIFICANTE

S4 BUSH SELF-LUBRICATING

S4 FÜHRUNGSBUCHSE

### S4.510.00

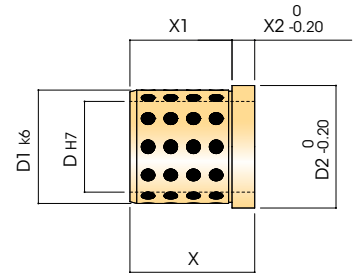

CODE	D	D1	X	D2	X1	X2
S451000.010014017	10	14	17	17	13	4
S451000.010014026	10	14	26	17	22	4
S451000.012016017	12	16	17	20	13	4
S451000.012016026	12	16	26	20	22	4
S451000.012016035	12	16	35	20	31	4
S451000.014020021	14	20	21	24	17	4
S451000.014020026	14	20	26	24	22	4
S451000.014020035	14	20	35	24	31	4
S451000.016020021	16	20	21	24	17	4
S451000.016020026	16	20	26	24	22	4
S451000.016020035	16	20	35	24	31	4
S451000.016020045	16	20	45	24	41	4
S451000.016020055	16	20	55	24	51	4
S451000.018025021	18	25	21	30	15	6
S451000.018025026	18	25	26	30	20	6
S451000.018025035	18	25	35	30	29	6
S451000.018025045	18	25	45	30	39	6
S451000.018025055	18	25	55	30	49	6
S451000.020030035	20	30	35	35	29	6
S451000.020030055	20	30	55	35	49	6
S451000.022030026	22	30	26	35	20	6
S451000.022030035	22	30	35	35	29	6
S451000.022030045	22	30	45	35	39	6
S451000.022030055	22	30	55	35	49	6
S451000.025035035	25	35	35	40	27	8
S451000.025035045	25	35	45	40	37	8
S451000.025035055	25	35	55	40	47	8
S451000.030040026	30	40	26	45	18	8
S451000.030040035	30	40	35	45	27	8
S451000.030040045	30	40	45	45	37	8
S451000.030040055	30	40	55	45	47	8
S451000.040050055	40	50	55	54	45	10

## S4 BUSSOLA BRONZO AUTOLUBRIFICANTE

S4 BUSH SELF-LUBRICATING

S4 FÜHRUNGSBUCHSE

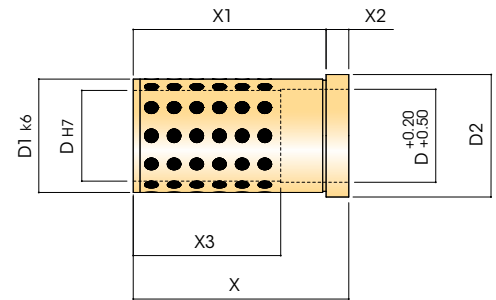

CODE	D	D1	X	D2	X1	X2
S451000.012016045	12	16	45	20	41	4
S451000.012016055	12	16	55	20	51	4
S451000.014020045	14	20	45	24	41	4
S451000.014020065	14	20	65	24	61	4
S451000.016020065	16	20	65	24	61	4
S451000.016020075	16	20	75	24	71	4
S451000.016020095	16	20	95	24	91	4
S451000.018025065	18	25	65	30	59	6
S451000.018025075	18	25	75	30	69	6
S451000.018025095	18	25	95	30	89	6
S451000.020030065	20	30	65	35	59	6
S451000.020030075	20	30	75	35	69	6
S451000.022030065	22	30	65	35	59	6
S451000.022030075	22	30	75	35	69	6
S451000.022030095	22	30	95	35	89	6
S451000.025035065	25	35	65	40	57	8
S451000.025035075	25	35	75	40	67	8
S451000.030040065	30	40	65	45	57	8
S451000.030040075	30	40	75	45	67	8
S451000.030040095	30	40	95	45	87	8
S451000.030040135	30	40	135	45	127	8
S451000.040050095	40	50	95	54	85	10

## S4 BUSSOLA BRONZO AUTOLUBRIFICANTE

S4 BUSH SELF-LUBRICATING

S4 FÜHRUNGSBUCHSE

### S4.510.01

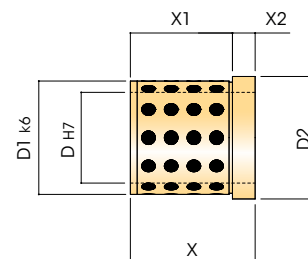

CODE	D	D1	X	D2	X1	X2
S451001.009014012	9	14	12	16	9	3
S451001.009014017	9	14	17	16	14	3
S451001.010014012	10	14	12	16	9	3
S451001.010014017	10	14	17	16	14	3
S451001.012018017	12	18	17	23	11	6
S451001.012018022	12	18	22	23	16	6
S451001.012018027	12	18	27	23	21	6
S451001.014020017	14	20	17	25	11	6
S451001.014020022	14	20	22	25	16	6
S451001.014020027	14	20	27	25	21	6
S451001.014020036	14	20	36	25	30	6
S451001.015020017	15	20	17	25	11	6
S451001.015020022	15	20	22	25	16	6
S451001.015020027	15	20	27	25	21	6
S451001.015020036	15	20	36	25	30	6
S451001.016022017	16	22	17	27	11	6
S451001.016022022	16	22	22	27	16	6
S451001.016022027	16	22	27	27	21	6
S451001.016022036	16	22	36	27	30	6
S451001.018026017	18	26	17	31	11	6
S451001.018026022	18	26	22	31	16	6
S451001.018026027	18	26	27	31	21	6
S451001.018026036	18	26	36	31	30	6
S451001.020026017	20	26	17	31	11	6
S451001.020026022	20	26	22	31	16	6
S451001.020026027	20	26	27	31	21	6
S451001.020026036	20	26	36	31	30	6
S451001.020026046	20	26	46	31	40	6
S451001.022030017	22	30	17	35	11	6

## S4 BUSSOLA BRONZO AUTOLUBRIFICANTE

S4 BUSH SELF-LUBRICATING

S4 FÜHRUNGSBUCHSE

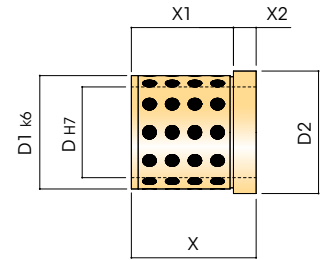

CODE	D	D1	X	D2	X1	X2
S451001.022030022	22	30	22	35	16	6
S451001.022030027	22	30	27	35	21	6
S451001.022030036	22	30	36	35	30	6
S451001.022030046	22	30	46	35	40	6
S451001.024030017	24	30	17	35	11	6
S451001.024030022	24	30	22	35	16	6
S451001.024030027	24	30	27	35	21	6
S451001.024030036	24	30	36	35	30	6
S451001.024030046	24	30	46	35	40	6
S451001.030042027	30	42	27	47	21	6
S451001.030042036	30	42	36	47	30	6
S451001.030042046	30	42	46	47	40	6
S451001.030042056	30	42	56	47	50	6
S451001.032042027	32	42	27	47	21	6
S451001.032042036	32	42	36	47	30	6
S451001.032042046	32	42	46	47	40	6
S451001.032042056	32	42	56	47	50	6
S451001.032042066	32	42	66	47	60	6
S451001.040054046	40	54	46	60	36	10
S451001.040054056	40	54	56	60	46	10
S451001.040054066	40	54	66	60	56	10
S451001.040054076	40	54	76	60	66	10
S451001.040054086	40	54	86	60	76	10
S451001.042054046	42	54	46	60	36	10
S451001.042054056	42	54	56	60	46	10
S451001.042054066	42	54	66	60	56	10
S451001.042054076	42	54	76	60	66	10
S451001.042054086	42	54	86	60	76	10

## S4 BUSSOLA BRONZO AUTOLUBRIFICANTE

S4 BUSH SELF-LUBRICATING

S4 FÜHRUNGSBUCHSE

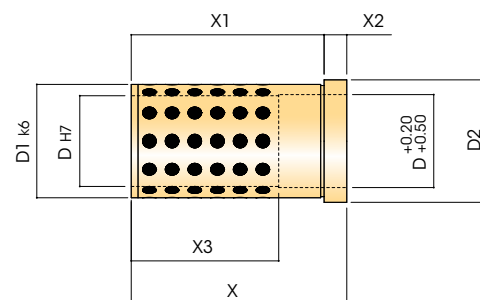

CODE	D	D1	X	D2	X1	X2	X3
S451001.009014022	9	14	22	16	19	3	18
S451001.009014027	9	14	27	16	24	3	18
S451001.009014036	9	14	36	16	33	3	18
S451001.009014046	9	14	46	16	43	3	18
S451001.009014056	9	14	56	16	53	3	18
S451001.010014022	10	14	22	16	19	3	20
S451001.010014027	10	14	27	16	24	3	20
S451001.010014036	10	14	36	16	33	3	20
S451001.010014046	10	14	46	16	43	3	20
S451001.010014056	10	14	56	16	53	3	20
S451001.012018036	12	18	36	23	30	6	24
S451001.012018046	12	18	46	23	40	6	24
S451001.012018056	12	18	56	23	50	6	24
S451001.014020046	14	20	46	25	40	6	28
S451001.014020056	14	20	56	25	50	6	28
S451001.015020046	15	20	46	25	40	6	30
S451001.015020056	15	20	56	25	50	6	30
S451001.016022046	16	22	46	27	40	6	32
S451001.016022056	16	22	56	27	50	6	32
S451001.018026046	18	26	46	31	40	6	36
S451001.018026056	18	26	56	31	50	6	36
S451001.018026066	18	26	66	31	60	6	36
S451001.018026076	18	26	76	31	70	6	36
S451001.020026056	20	26	56	31	50	6	40
S451001.020026066	20	26	66	31	60	6	40
S451001.020026076	20	26	76	31	70	6	40
S451001.022030056	22	30	56	35	50	6	44
S451001.022030066	22	30	66	35	60	6	44
S451001.022030076	22	30	76	35	70	6	44
S451001.022030086	22	30	86	35	80	6	44
S451001.022030096	22	30	96	35	90	6	44
S451001.024030056	24	30	56	35	50	6	48
S451001.024030066	24	30	66	35	60	6	48
S451001.024030076	24	30	76	35	70	6	48
S451001.024030086	24	30	86	35	80	6	48

## S4 BUSSOLA BRONZO AUTOLUBRIFICANTE

S4 BUSH SELF-LUBRICATING

S4 FÜHRUNGSBUCHSE

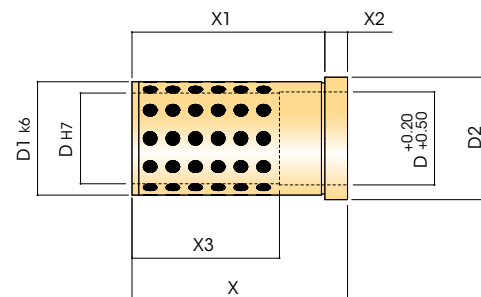

CODE	D	D1	X	D2	X1	X2	X3
S451001.024030096	24	30	96	35	90	6	48
S451001.030042066	30	42	66	47	60	6	60
S451001.030042076	30	42	76	47	70	6	60
S451001.030042086	30	42	86	47	80	6	60
S451001.030042096	30	42	96	47	90	6	60
S451001.030042116	30	42	116	47	110	6	60
S451001.032042076	32	42	76	47	70	6	64
S451001.032042086	32	42	86	47	80	6	64
S451001.032042096	32	42	96	47	90	6	64
S451001.032042116	32	42	116	47	110	6	64
S451001.040054096	40	54	96	60	86	10	80
S451001.040054116	40	54	116	60	106	10	80
S451001.040054136	40	54	136	60	126	10	80
S451001.040054156	40	54	156	60	146	10	80
S451001.042054096	42	54	96	60	86	10	84
S451001.042054116	42	54	116	60	106	10	84
S451001.042054136	42	54	136	60	126	10	84
S451001.042054156	42	54	156	60	146	10	84

## S4.510.02

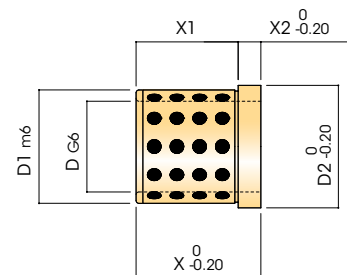

CODE	D	D1	X	D2	X1	X2
S451002.012018019	12	18	19	25	15	4
S451002.012018024	12	18	24	25	20	4
S451002.012018029	12	18	29	25	25	4



## S4 BUSSOLA BRONZO AUTOLUBRIFICANTE

S4 BUSH SELF-LUBRICATING

S4 FÜHRUNGSBUCHSE

CODE	D	D1	X	D2	X1	X2
S451002.012018034	12	18	34	25	30	4
S451002.016025019	16	25	19	30	13	6
S451002.016025024	16	25	24	30	18	6
S451002.016025029	16	25	29	30	23	6
S451002.020030024	20	30	24	35	16	8
S451002.020030029	20	30	29	35	21	8
S451002.020030034	20	30	34	35	26	8
S451002.020030039	20	30	39	35	31	8
S451002.025035024	25	35	24	40	16	8
S451002.025035029	25	35	29	40	21	8
S451002.025035034	25	35	34	40	26	8
S451002.025035039	25	35	39	40	31	8
S451002.025035049	25	35	49	40	41	8
S451002.030042029	30	42	29	47	19	10
S451002.030042034	30	42	34	47	24	10
S451002.030042039	30	42	39	47	29	10
S451002.030042049	30	42	49	47	39	10
S451002.030042059	30	42	59	47	49	10
S451002.035048039	35	48	39	54	29	10
S451002.035048049	35	48	49	54	39	10
S451002.035048059	35	48	59	54	49	10
S451002.035048069	35	48	69	54	59	10
S451002.040055039	40	55	39	61	29	10
S451002.040055049	40	55	49	61	39	10
S451002.040055059	40	55	59	61	49	10
S451002.040055069	40	55	69	61	59	10
S451002.040055079	40	55	79	61	69	10
S451002.050070049	50	70	49	76	37	12
S451002.050070059	50	70	59	76	47	12
S451002.050070069	50	70	69	76	57	12
S451002.050070079	50	70	79	76	67	12
S451002.050070089	50	70	89	76	77	12
S451002.060080099	60	80	99	86	84	15
S451002.060080109	60	80	109	86	94	15

## S4 BUSSOLA BRONZO AUTOLUBRIFICANTE

S4 BUSH SELF-LUBRICATING

S4 FÜHRUNGSBUCHSE

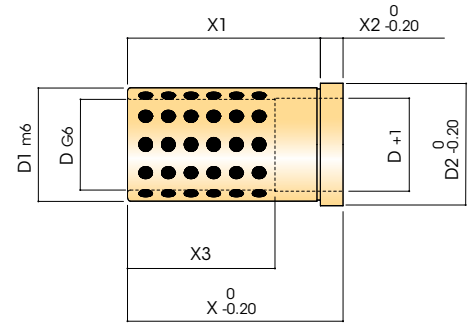

CODE	D	D1	X	D2	X1	X2	X3
S451002.016025034	16	25	34	30	28	6	30
S451002.016025039	16	25	39	30	33	6	30
S451002.016025049	16	25	49	30	43	6	30
S451002.020030049	20	30	49	35	41	8	40
S451002.020030059	20	30	59	35	51	8	40
S451002.025035059	25	35	59	40	51	8	50
S451002.025035069	25	35	69	40	61	8	50
S451002.030042069	30	42	69	47	59	10	60
S451002.030042079	30	42	79	47	69	10	60
S451002.035048079	35	48	79	54	69	10	70
S451002.035048089	35	48	89	54	79	10	70
S451002.035048099	35	48	99	54	89	10	70
S451002.040055089	40	55	89	61	79	10	80
S451002.040055099	40	55	99	61	89	10	80
S451002.040055109	40	55	109	61	99	10	80
S451002.050070099	50	70	99	76	87	12	90
S451002.050070109	50	70	109	76	97	12	90
S451002.050070119	50	70	119	76	107	12	90
S451002.060080119	60	80	119	86	104	15	110
S451002.060080129	60	80	129	86	114	15	110
S451002.060080149	60	80	149	86	134	15	110

## S4 BUSSOLA BRONZO AUTOLUBRIFICANTE

S4 BUSH SELF-LUBRICATING

S4 FÜHRUNGSBUCHSE

### S4.510.10

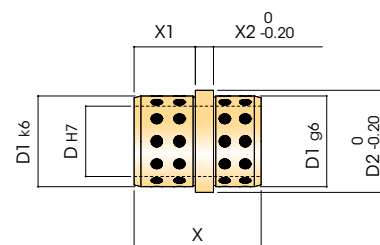

CODE	D	D1	X	D2	X1	X2
S451010.012016025	12	16	25	20	13	4
S451010.012016034	12	16	34	20	22	4
S451010.016020029	16	20	29	24	13	4
S451010.016020033	16	20	33	24	17	4
S451010.016020038	16	20	38	24	22	4
S451010.016020047	16	20	47	24	31	4
S451010.018025038	18	25	38	30	15	6
S451010.018025043	18	25	43	30	20	6
S451010.018025052	18	25	52	30	29	6
S451010.022030038	22	30	38	35	15	6
S451010.022030043	22	30	43	35	20	6
S451010.022030052	22	30	52	35	29	6
S451010.030040056	30	40	56	45	27	8

## S4 BUSSOLA BRONZO AUTOLUBRIFICANTE

S4 BUSH SELF-LUBRICATING

S4 FÜHRUNGSBUCHSE

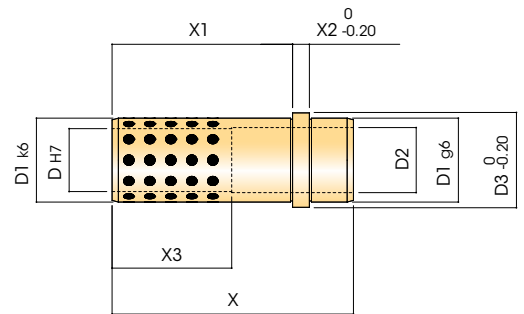

CODE	D	D1	X	D2	D3	X1	X2	X3
S451010.012016043	12	16	43	12,5	20	31	4	27
S451010.012016053	12	16	53	12,5	20	41	4	27
S451010.012016063	12	16	63	12,5	20	51	4	27
S451010.016020057	16	20	57	16,5	24	41	4	30
S451010.016020067	16	20	67	16,5	24	51	4	40
S451010.016020086	16	20	86	16,5	24	70	4	56
S451010.018025072	18	25	72	19	30	49	6	38
S451010.018025091	18	25	91	19	30	68	6	44
S451010.018025111	18	25	111	19	30	88	6	56
S451010.022030072	22	30	72	23	35	49	6	38
S451010.022030091	22	30	91	23	35	68	6	44
S451010.022030111	22	30	111	23	35	88	6	57
S451010.030040076	30	40	76	31	45	47	8	44
S451010.030040095	30	40	95	31	45	66	8	43
S451010.030040115	30	40	115	31	45	86	8	58

## S4 BUSSOLA BRONZO AUTOLUBRIFICANTE

S4 BUSH SELF-LUBRICATING

S4 FÜHRUNGSBUCHSE

### S4.510.11

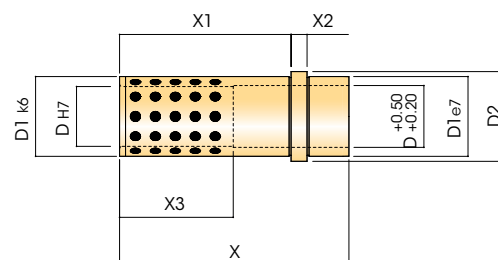

CODE	D	D1	X	D2	X1	X2	X3
S451011.009014020	9	14	20	16	14	3	18
S451011.009014025	9	14	25	16	19	3	18
S451011.009014030	9	14	30	16	24	3	18
S451011.009014039	9	14	39	16	33	3	18
S451011.009014049	9	14	49	16	43	3	18
S451011.009014059	9	14	59	16	56	3	18
S451011.009014069	9	14	69	16	63	3	18
S451011.010014025	10	14	25	16	19	3	20
S451011.010014030	10	14	30	16	24	3	20
S451011.010014039	10	14	39	16	33	3	20
S451011.010014049	10	14	49	16	43	3	20
S451011.010014059	10	14	59	16	53	3	20
S451011.010014069	10	14	69	16	63	3	20
S451011.014020033	14	20	33	25	21	6	28
S451011.014020042	14	20	42	25	30	6	28
S451011.014020052	14	20	52	25	40	6	28
S451011.014020062	14	20	62	25	50	6	28
S451011.014020072	14	20	72	25	60	6	28
S451011.014020082	14	20	82	25	70	6	28
S451011.014020092	14	20	92	25	80	6	28
S451011.015020033	15	20	33	25	21	6	30
S451011.015020042	15	20	42	25	30	6	30
S451011.015020052	15	20	52	25	40	6	30
S451011.015020062	15	20	62	25	50	6	30
S451011.015020072	15	20	72	25	60	6	30
S451011.015020082	15	20	82	25	70	6	30
S451011.015020092	15	20	92	25	80	6	30
S451011.018026044	18	26	44	31	30	6	36
S451011.018026054	18	26	54	31	40	6	36

## S4 BUSSOLA BRONZO AUTOLUBRIFICANTE

S4 BUSH SELF-LUBRICATING

S4 FÜHRUNGSBUCHSE

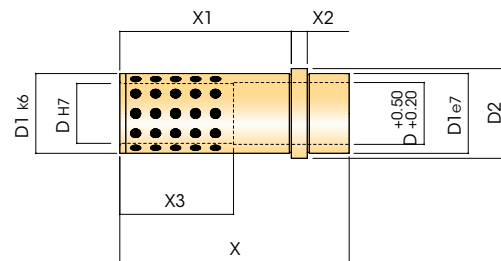

CODE	D	D1	X	D2	X1	X2	X3
S451011.018026064	18	26	64	31	50	6	36
S451011.018026074	18	26	74	31	60	6	36
S451011.018026084	18	26	84	31	70	6	36
S451011.018026094	18	26	94	31	80	6	36
S451011.018026104	18	26	104	31	90	6	36
S451011.018026124	18	26	124	31	110	6	36
S451011.020026044	20	26	44	31	30	6	40
S451011.020026054	20	26	54	31	40	6	40
S451011.020026064	20	26	64	31	50	6	40
S451011.020026074	20	26	74	31	60	6	40
S451011.020026084	20	26	84	31	70	6	40
S451011.020026094	20	26	94	31	80	6	40
S451011.020026104	20	26	104	31	90	6	40
S451011.020026124	20	26	124	31	110	6	40
S451011.022030054	22	30	54	35	40	6	44
S451011.022030064	22	30	64	35	50	6	44
S451011.022030074	22	30	74	35	60	6	44
S451011.022030084	22	30	84	35	70	6	44
S451011.022030094	22	30	94	35	80	6	44
S451011.022030104	22	30	104	35	90	6	44
S451011.022030124	22	30	124	35	110	6	44
S451011.022030144	22	30	144	35	130	6	44
S451011.022030164	22	30	164	35	150	6	44
S451011.024030054	24	30	54	35	40	6	48
S451011.024030064	24	30	64	35	50	6	48
S451011.024030074	24	30	74	35	60	6	48
S451011.024030084	24	30	84	35	70	6	48
S451011.024030094	24	30	94	35	80	6	48
S451011.024030104	24	30	104	35	90	6	48
S451011.024030124	24	30	124	35	110	6	48
S451011.024030144	24	30	144	35	130	6	48
S451011.024030164	24	30	164	35	150	6	48
S451011.030042064	30	42	64	47	50	6	60
S451011.030042074	30	42	74	47	60	6	60

## S4 BUSSOLA BRONZO AUTOLUBRIFICANTE

S4 BUSH SELF-LUBRICATING

S4 FÜHRUNGSBUCHSE

CODE	D	D1	X	D2	X1	X2	X3
S451011.030042084	30	42	84	47	70	6	60
S451011.030042094	30	42	94	47	80	6	60
S451011.030042104	30	42	104	47	90	6	60
S451011.030042124	30	42	124	47	110	6	60
S451011.030042144	30	42	144	47	130	6	60
S451011.032042074	32	42	74	47	60	6	64
S451011.032042084	32	42	84	47	70	6	64
S451011.032042094	32	42	94	47	80	6	64
S451011.032042104	32	42	104	47	90	6	64
S451011.032042124	32	42	124	47	110	6	64
S451011.032042144	32	42	144	47	130	6	64
S451011.040054088	40	54	88	60	66	10	80
S451011.040054098	40	54	98	60	76	10	80
S451011.040054108	40	54	108	60	86	10	80
S451011.040054128	40	54	128	60	106	10	80
S451011.040054148	40	54	148	60	126	10	80
S451011.040054168	40	54	168	60	146	10	80
S451011.040054208	40	54	208	60	186	10	80
S451011.042054088	42	54	88	60	66	10	84
S451011.042054098	42	54	98	60	76	10	84
S451011.042054108	42	54	108	60	86	10	84
S451011.042054128	42	54	128	60	106	10	84
S451011.042054148	42	54	148	60	126	10	84
S451011.042054168	42	54	168	60	146	10	84
S451011.042054208	42	54	208	60	186	10	84

## S4 BUSSOLA BRONZO AUTOLUBRIFICANTE

S4 BUSH SELF-LUBRICATING

S4 FÜHRUNGSBUCHSE

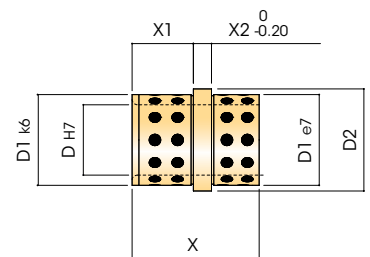

CODE	D	D1	X	D2	X1	X2
S451011.009014015	9	14	15	16	9	3
S451011.010014015	10	14	15	16	9	3
S451011.010014020	10	14	20	16	14	3
S451011.014020023	14	20	23	25	11	6
S451011.014020028	14	20	28	25	16	6
S451011.015020023	15	20	23	25	11	6
S451011.015020028	15	20	28	25	16	6
S451011.018026025	18	26	25	31	11	6
S451011.018026030	18	26	30	31	16	6
S451011.018026035	18	26	35	31	21	6
S451011.020026025	20	26	25	31	11	6
S451011.020026030	20	26	30	31	16	6
S451011.020026035	20	26	35	31	21	6
S451011.022030025	22	30	25	35	11	6
S451011.022030030	22	30	30	35	16	6
S451011.022030035	22	30	35	35	21	6
S451011.022030044	22	30	44	35	30	6
S451011.024030025	24	30	25	35	11	6
S451011.024030030	24	30	30	35	16	6
S451011.024030035	24	30	35	35	21	6
S451011.024030044	24	30	44	35	30	6
S451011.030042035	30	42	35	47	21	6
S451011.030042044	30	42	44	47	30	6
S451011.030042054	30	42	54	47	40	6
S451011.032042035	32	42	35	47	21	6
S451011.032042044	32	42	44	47	30	6
S451011.032042054	32	42	54	47	40	6
S451011.032042064	32	42	64	47	50	6
S451011.040054058	40	54	58	60	36	10
S451011.040054068	40	54	68	60	46	10
S451011.040054078	40	54	78	60	56	10
S451011.042054058	42	54	58	60	36	10
S451011.042054068	42	54	68	60	46	10
S451011.042054078	42	54	78	60	56	10



## S4 BUSSOLA BRONZO AUTOLUBRIFICANTE

S4 BUSH SELF-LUBRICATING

S4 FÜHRUNGSBUCHSE

### S4.510.12

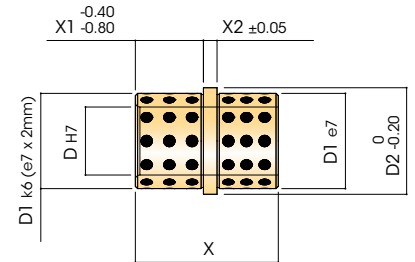

CODE	D	D1	X	D2	X1	X2
S451012.009014015	9	14	15	16	6	3
S451012.010014026	10	14	26	16	14	3
S451012.014020026	14	20	26	25	11	6
S451012.015020026	15	20	26	25	11	6
S451012.018026039	18	26	39	31	16	6
S451012.020026039	20	26	39	31	16	6
S451012.022030049	22	30	49	35	21	6
S451012.024030049	24	30	49	35	21	6
S451012.030042063	30	42	63	47	30	6
S451012.032042063	32	42	63	47	30	6

## S4.510.13

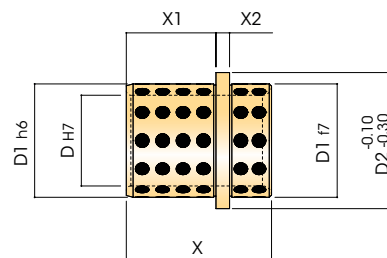

CODE	D	D1	X	D2	X1	X2
S451013.025035043	25	35	43	40	24	7,5
S451013.030042043	30	42	43	47	24	7,5
S451013.040050060	40	50	60	60	35,5	6
S451013.040050064	40	50	64	60	39,5	6
S451013.050063077	50	63	77	72	44,5	8
S451013.050063092	50	63	92	72	55,5	8
S451013.060080078	60	80	78	86	49	7,5
S451013.063080095	63	80	95	90	55,5	8
S451013.063080100	63	80	100	90	62,5	8
S451013.063080108	63	80	108	90	62,5	8





# RALL DI SCORRIMENTO AUTOLUBRIFICANTE S8

THRUST WASHER SELF-LUBRICATING  
ANLAUFSCHEIBE BRONZE MIT FESTSCHMIERSTOFF

**MATERIAL** BRONZE with solid lubricant **HARDENESS** >190 HB

## S8 RALL DI SCORRIMENTO AUTOLUBRICANTE

S8 THRUST WASHER SELF-LUBRICATING

S8 ANLAUFSCHIBE BRONZE MIT FESTCHMIERSTOFF

### S8.100.00

AFNOR/CNOMO

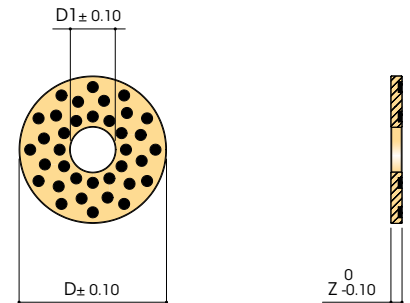

CODE	D	D1	Z
S810000.003001003	30	10,2	3
S810000.004001203	40	12,2	3
S810000.005001603	50	16,2	3

CODE	D	D1	Z
S810000.005002005	50	20,2	5
S810000.005502505	55	25,2	5
S810000.006003005	60	30,2	5

### S8.100.10

AFNOR/CNOMO

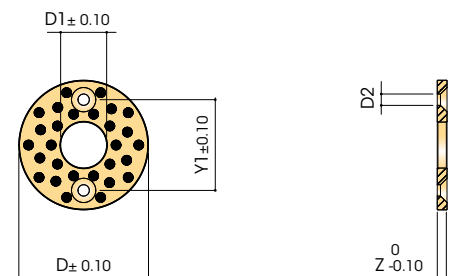

CODE	D	D1	Z	Y1	D2
S810010.003001003	30	10,2	3	20	3,5
S810010.004001203	40	12,2	3	28	3,5
S810010.004001303	40	13,2	3	28	3,5
S810010.004001403	40	14,2	3	28	3,5
S810010.005001503	50	15,2	3	28	3,5
S810010.005001603	50	16,2	3	28	3,5
S810010.005001803	50	18,2	3	35	3,5

CODE	D	D1	Z	Y1	D2
S810010.005002005	50	20,2	5	35	5,5
S810010.005502505	55	25,2	5	40	5,5
S810010.006003005	60	30,2	5	45	5,5
S810010.007003505	70	35,2	5	50	5,5
S810010.008004007	80	40,2	7	60	6,8
S810010.009004507	90	45,3	7	67,5	6,8

## S8 RALL DI SCORRIMENTO AUTOLUBRICANTE

S8 THRUST WASHER SELF-LUBRICATING

S8 ANLAUFSCHLEIBE BRONZE MIT FESTSCHMIERSTOFF

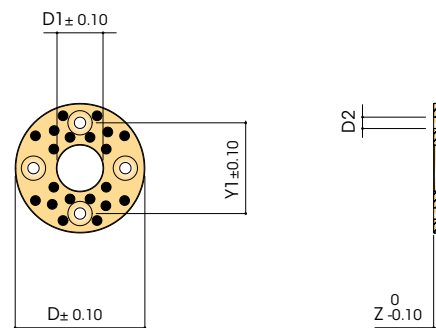

CODE	D	D1	Z	Y1	D2
<a href="#">S810010.010005008</a>	100	50,3	8	75	6,8
<a href="#">S810010.011005508</a>	110	55,3	8	85	6,8
<a href="#">S810010.012006008</a>	120	60,3	8	90	9
<a href="#">S810010.012506508</a>	125	65,3	8	95	9
<a href="#">S810010.013007010</a>	130	70,3	10	100	9

CODE	D	D1	Z	Y1	D2
<a href="#">S810010.014007510</a>	140	75,3	10	110	9
<a href="#">S810010.015008010</a>	150	80,3	10	120	9
<a href="#">S810010.017009010</a>	170	90,5	10	140	11
<a href="#">S810010.019010010</a>	190	100,5	10	160	11
<a href="#">S810010.020012010</a>	200	120,5	10	175	11





NOTES

---

---

---

---

---

---

---

---

---

---

---

---

---

---

---

---

---

---

---

---

---

---

---

---

---



**SYSTARK srl**

Via I Maggio 10  
40011 Anzola dell'Emilia  
Bologna / Italy

T +39 051 0561910  
F +39 051 0561911

**info@systark.it**  
**systark.it**





**SYSTARK srl**

Via I Maggio 10  
40011 Anzola dell'Emilia  
Bologna / Italy

T +39 051 0561910

F +39 051 0561911

[info@systark.it](mailto:info@systark.it)

[systark.it](http://systark.it)